

*Ford*  
MANUAL

*Ford Motor Company*  
DETROIT, MICH.



# FORD MANUAL

For Owners and Operators  
of Ford Cars and Trucks

Copyrighted 1926  
by  
Ford Motor Company  
All rights reserved

*Published by*  
FORD MOTOR COMPANY  
Detroit, Michigan, U. S. A.

## The Car and Its Operation

### Foreword

**I**T is a significant fact that nearly all Ford cars are driven by laymen—by owners, who in the great majority of cases have little or no practical experience with things mechanical.

The simplicity of the Ford car and the ease with which it is operated renders an intimate knowledge of mechanical technicalities unnecessary for its operation.

And the further fact that there are more than forty thousand Ford service stations distributed throughout the United States where adjustments and repairs can be obtained with no annoying delay—gives to Ford owners a singular freedom from mechanical annoyances which beset owners of cars having limited service facilities and distribution.

But while it is not imperative, it is, however, altogether desirable that every Ford owner should thoroughly understand his car. With such knowledge at his command he is always master of the situation—he will maintain his car more economically—prolong its usefulness—and he will also derive more pleasure from it, for it is a truism that the more one knows about a thing the more one enjoys it.

The mastery of a thorough knowledge of Ford construction is by no means a difficult or time-consuming task. The Ford is the simplest car made. It is easy to understand, and is not difficult to keep in proper adjustment and repair.

That the Ford construction may be thoroughly understood—and that there may be an authoritative guide for the making of Ford adjustments—this book is published.

### Important

*It is most important that owners of Ford cars shall insist upon getting the genuine Ford-made materials, or "Parts," when having repairs or replacements made. This will be assured when the car is taken to the authorized Ford dealer. Imitation, or "bogus" or counterfeit parts of inferior quality are being made and sold as "Ford Parts." Avoid their use by dealing with the authorized Ford dealer.*

*What must be done before starting the Car?*

*Answer No. 1*

Before starting the car, fill the radiator (by removing cap at top) with clean fresh water. If perfectly clean water cannot be obtained it is advisable to strain it through muslin or other similar material to prevent foreign matter from getting in and obstructing the small tubes of the radiator. The system will hold approximately three gallons. It is important that the car should not be run under its own power unless the water circulating system has been filled. Pour in the water until you are sure that both radiator and cylinder water jackets are full. The water will run out of the overflow pipe onto the ground when the entire water system has been properly filled. During the first few days that a new car is being driven it is a good plan to examine the radiator frequently and see that it is kept properly filled. The water supply should be replenished as often as may be found necessary. Soft rain water, when it is to be had in a clean state, is superior to hard water, which may contain alkalies and other salts which tend to deposit sediment and clog the radiator. (See chapter on Cooling System.)

*What about Gasoline?*

*Answer No. 2*

The ten-gallon gasoline tank should be filled—nearly full—and the supply should never be allowed to get low. When filling the tank be sure that there are no naked flames within several feet, as the vapor is extremely volatile and travels rapidly. Always be careful about lighting matches near where gasoline has been spilled, as the air within a radius of several feet is permeated with the highly explosive vapor. The small vent hole in the gasoline tank cap should not be allowed to get plugged up, as this would prevent proper flow of the gasoline to the carburetor. The gasoline tank may be drained by opening the pet cock in the sediment bulb.

*How about the Oiling System?*

*Answer No. 3*

Upon receipt of the car see that a supply of medium light, high-grade gas engine oil is poured into the crank case through the breather pipe at the front of the engine (a metal cap covers it). Down under the car in the flywheel casing (the reservoir which holds this oil) you will find two pet cocks. Pour oil in slowly until it runs out of the upper cock. Leave the cock open until it stops running—then close it. After the engine has become thoroughly limbered up, the best results will be obtained by carrying the oil at a level midway between the two cocks—but under no circumstances should it be allowed to get below the lower cock. All other parts of the car are properly oiled when it leaves the factory. However, it will be well to see that all grease cups are filled and that oil is supplied to necessary parts. (See Cut No. 16, also chapter on Lubrication.)

*How are Spark and Throttle Levers used?*

*Answer No. 4*

Under the steering wheel are two small levers. The right-hand (throttle) lever controls the amount of mixture (gasoline and air) which goes into the engine. When the engine is in operation, the farther this lever is moved downward toward the driver (referred to as "opening the throttle") the faster the engine runs and the greater the power furnished. The left-hand lever controls the spark, which explodes the gas in the cylinders of the engine. The advancing of this lever



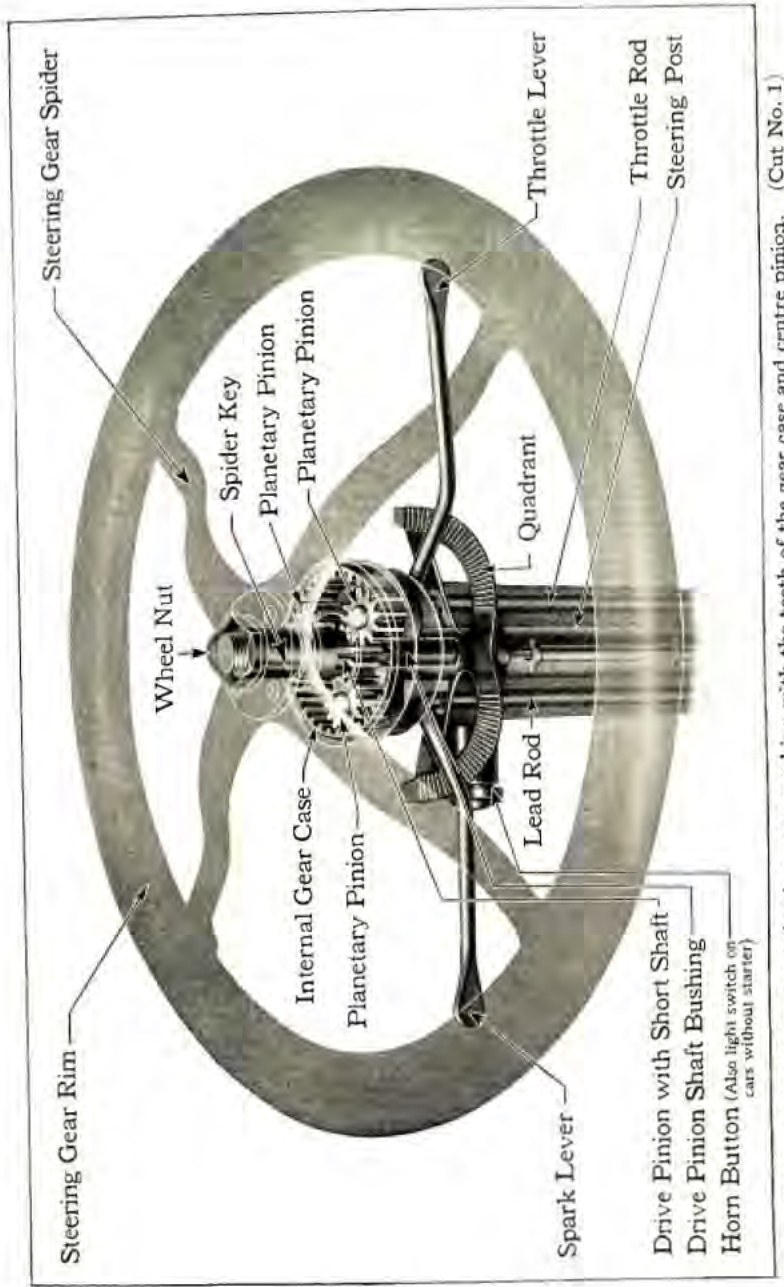

Steering Wheel, showing reduction gears meshing with the teeth of the gear case and centre pinion. (Cut No. 1)

"advances the spark," and it should be moved down notch by notch until the motor seems to reach its maximum speed. If the lever is advanced beyond this point a dull knock will be noticed in the engine. (See chapter on Ignition.)

*Where should these levers be when starting the Engine?*

**Answer No. 5**

The spark lever should usually be fully retarded (all the way up on the quadrant—the notched half-circle on which the levers operate). The throttle should usually be placed in about the fifth or sixth notch. A little experience will soon teach you where these levers should be placed for proper starting. Care should be taken not to advance the spark lever too far, as the engine may "back kick."

*What else is necessary before starting the Engine?*

**Answer No. 6**

First: See that the hand lever, which extends through the floor of the car at the left of the driver, is pulled back as far as it will go. The lever in this position holds the clutch in neutral and engages the hub brake, thus preventing the car moving forward when the engine is started. Second: On cars without starters, insert the switch key into the switch and turn the key as far to the left (counter-clockwise) as it will go. On cars equipped with starters the switch key may be turned either to the right or left. The engine cannot be started until the switch is turned on—the turning of the switch key to a vertical position stops the engine.

*How is the Engine started?*

**Answer No. 7**

If the car is not equipped with a starter the engine is started by the lifting of the starting crank at the front of the car. Take hold of the handle and push firmly toward the car till you feel the crank ratchet engage, then lift upward with a quick swing. With a little experience this operation will become an easy matter. Don't, as a usual thing, crank downward against compression—for then an early explosion may drive the handle vigorously backward. This does not mean however, that it is not advisable, when the car is hard to start, to occasionally "spin" the engine by the use of the starting handle—but be sure the spark lever is retarded when spinning or cranking the engine against compression, otherwise a sudden back kick may injure the arm of the operator. When the engine is cool it is advisable to prime the carburetor by pulling on the small wire at the lower left corner of the radiator while giving the engine two or three quarter turns with the starting handle. If the car is equipped with a starter the throttle lever should be placed in the same position on the quadrant as when cranking by hand, and the spark lever should be fully retarded. The ignition switch may then be turned on. Current from either battery or magneto may be used for ignition. However, we recommend that the magneto be used at all times. The magneto was designed to furnish ignition for the Model T engine and better results will be obtained by operating in this way. Special attention must be paid to the position of the spark lever, as a too advanced spark will cause serious backfiring which in turn will bend or break the shaft in the starter. The starting motor is operated by a push button, conveniently located in the floor of the car at the driver's feet. With the spark and throttle levers in the proper position, and the ignition switch turned on, press on the push button with the foot. This closes the circuit between the battery and starting motor, causing the pinion of the starter drive shaft to engage with the teeth on the flywheel, thus turning over the crankshaft. When the engine is cold it may be necessary to prime it by pulling out the carburetor priming rod, which is located on the instrument board. In order to avoid flooding the engine with an over rich mixture of gas, the priming rod should only be held out for a few seconds at a time.



**How is the Engine best started in cold weather?**

**Answer No. 8**

As gasoline does not vaporize readily in cold weather it is naturally more difficult to start the motor under such conditions. The usual method of starting the engine when cold is to turn the carburetor dash adjustment one-quarter turn to the left in order to allow a richer mixture of gasoline to be drawn into the cylinders; then hold out the priming rod, while you turn the crank from six to eight one-quarter turns in quick succession, or turn the motor over a few times with the starter. Another method of starting a troublesome cold engine is as follows: Before you turn on the switch, (1) close throttle lever; (2) hold out priming rod while you give crank several quick turns, or turn the motor over a few times with the starter, then let go of priming rod (being careful that it goes back all the way); (3) fully retard spark lever and advance throttle lever several notches; (4) turn on switch; (5) give crank one or two turns, or close the starting switch, and the motor should start. After starting the motor it is advisable to advance the spark eight or ten notches on the quadrant and let the motor run until thoroughly warmed. If you start out with a cold motor you will not have much power and are liable to "stall." The advantage of turning on the switch last, or after priming, is that when you throw on the switch and start the motor, you have plenty of gas in the cylinders, to keep the motor running, thereby eliminating the trouble of the motor starting and stopping. After motor is warmed up turn carburetor adjustment back one-quarter turn.

**What function does the Hand Lever perform?**

**Answer No. 9**

Its chief purpose is to hold the clutch in neutral position. If it were not for this lever the driver would have to stop the engine whenever he left the driver's seat. He would also be unable to crank the engine without the car starting forward with the first explosion. When pulled back as far as it will go, the hand lever acts as an emergency brake on the rear wheels, by expanding the brake shoes in the rear wheel drums. Therefore the hand lever should be back as far as it will go when cranking the engine or when the car is at rest. It should be in a vertical position, and not far enough backward to act as a brake on the rear wheels, when the car is to be reversed. When the car is operating in high or low speed the hand lever should be all the way forward.

**How do the Foot Pedals operate?**

**Answer No. 10**

The first one toward the left operates the clutch. When pressed forward the clutch pedal engages the low speed. When half-way forward the clutch is in neutral (i. e., disconnected from the driving mechanism of the rear wheels), and the releasing of this pedal engages the high-speed clutch. The center pedal operates the reverse. The right-hand pedal operates the transmission brake.

**How is the Car started?**

**Answer No. 11**

Slightly accelerate the engine by opening the throttle, press the clutch pedal half way forward, thereby holding the clutch in a neutral position while throwing the hand lever forward; then press the pedal forward into slow speed and when under sufficient headway (20 to 30 feet), allow the pedal to drop back slowly into high speed, at the same time partially closing the throttle, which will allow the engine to pick up its load easily. With a little practice, the change of speeds will be easily accomplished, and without any appreciable effect on the smooth running of the machine.

**How is the Car stopped?**

**Answer No. 12**

Partially close the throttle; release the high speed by pressing the clutch pedal forward into neutral; apply the foot brake slowly but firmly until the car comes to a dead stop. Do not remove foot from the clutch pedal without first pulling the hand lever back to neutral position, or the engine will stall. To stop the motor turn off the switch.

Endeavor to so familiarize yourself with the operation of the car that to disengage the clutch and apply the brake becomes practically automatic—the natural thing to do in case of emergency.

**How is the Car reversed?**

**Answer No. 13**

It must be brought to a dead stop. With the engine running, disengage the clutch with the hand lever and press the reverse pedal forward with the left foot, the right foot being free to use on the brake pedal if needed. Do not bring the hand lever back too far or you will set the brakes on the rear wheels. Experienced drivers ordinarily reverse the car by simply holding the clutch pedal in neutral with the left foot, and operating the reverse pedal with the right.

**How is the Spark controlled?**

**Answer No. 14**

By the left-hand lever under the steering wheel. Good operators drive with the spark lever advanced just as far as the engine will permit. However, advancing the spark too far will cause a dull knock in the motor, due to the fact that the explosion occurs too early. The spark should only be retarded when the engine slows down on a heavy road or steep grade, but care should be exercised not to retard the spark too far as this will result in late ignition, which causes loss of power and overheating of the motor and may also result in warped, burned or cracked valves. Learn to operate the spark as the occasion demands. The greatest economy in gasoline consumption is obtained by driving with the spark advanced sufficiently to obtain the maximum speed.

**How is speed of Car controlled?**

**Answer No. 15**

The different speeds required to meet road conditions are obtained by opening or closing the throttle. Practically all the running speeds needed for ordinary travel are obtained on high gear, and it is seldom necessary to use the low gear except to give the car momentum in starting. The speed of the car may be temporarily slackened in driving through crowded traffic, turning corners, etc., by "slipping the clutch," i. e., pressing the clutch pedal forward into neutral. When doing this the throttle lever should be nearly closed.

**Is it advisable for owners to make their own Adjustments?**

**Answer No. 16**

The Ford is the simplest of all cars. Most of the ordinary adjustments an owner will soon learn to make for himself. But we must strongly recommend that when it becomes necessary to employ the services of a mechanic, the car be taken to a Ford mechanic—one of our own representatives who thoroughly understands the car—and who will have no motive for running up useless repair bills. The



entire Ford organization is interested in keeping every individual Ford car in constant operation, at the lowest possible cost. We have known of much damage done to many cars by unskilled repair men.

**What attention  
does the Car need?**

**Answer No. 17**

Remember that a new machine requires more careful attention during the first few days it is being driven than after the parts have become thoroughly "worked in." The car which is driven slowly and carefully when new usually gives the most satisfactory service in the end. Never start out with your car until you are sure that it has plenty of oil, water and fuel. Frequently inspect the running gear. See that no unnecessary play exists in either front or rear wheels, and that all bolts and nuts are tight. Make a practice of taking care of every repair or adjustment as soon as its necessity is discovered. This attention requires but little time and may avoid delay or possible accident on the road. We aim to deliver the car in proper mechanical adjustment. Afterwards it is plainly the duty of the driver to keep it in that condition.

## The Ford Engine

**What is the principle of the  
gasoline-driven Engine?**

**Answer No. 18**

Gasoline when mixed with air and compressed is highly explosive. An explosion is a violent expansion caused by instantaneous combustion of confined gases. In the gasoline engine the mixture is drawn into a cylinder, where it is compressed by an advancing piston and then exploded by an electric spark, which sends the piston downward, and through the connecting rod imparts a rotary motion to the crankshaft.

**What are functions  
of the Pistons?**

**Answer No. 19**

On the downward stroke the suction of the piston draws the fresh gas from the carburetor, through the inlet pipe and valve, into the cylinder. The upward movement of the piston compresses the gas into a very small space, between the top of the piston and the depression in the cylinder head, known as the "combustion chamber." (The compressed gases exert a pressure of approximately 60 pounds per square inch.) At this point the electric spark explodes the gases—driving the piston downward—thus producing the power which turns the crankshaft. On the next stroke upward the piston drives the exploded gas out through the exhaust valve and pipe to the muffler. (See Cut No. 2.)

**Connecting Rod—  
how removed?**

**Answer No. 20**

It is a steel rod, connecting piston and crank shaft. Should the babbitt bearing become worn, or burned out through lack of oil, a knocking in the engine will result—in which case the entire connecting rod should be replaced. To make this replacement, (1) drain oil from crank case; (2) take off cylinder head; (3) remove detachable plate on bottom of crank case; (4) disconnect connecting rod from crank shaft; (5) take piston and rod out through top of cylinder.

When replacing a rod on which babbitt has burned out, make sure the crankshaft is free from any babbitt left by the burned out rod. This babbitt can be removed by means of a piece of oiled sandpaper.

**What is the Valve  
Arrangement?**

**Answer No. 21**

One intake and one exhaust valve are located in each cylinder. The former admits the fresh gas drawn from the carburetor through the inlet pipe—the latter permits the exploded gas to be driven out through the exhaust pipe. The valves are alternately opened and closed (see Cut No. 2) by the cams on the cam shaft striking against push rods which in turn lift the valves from their seats.

**What about  
Valve timing?**

**Answer No. 22**

In timing the engine the points of opening and closing of the valves are, of course, what should be considered. As the valves are properly timed at the factory when the engine is built the necessity for retiming would occur only when such parts as the cam shaft, time gears or valves were removed in overhauling the engine.

The time gears must mesh so that the tooth marked "Ford" on the small time gear will come between the two teeth on the large gear at the point marked zero (0). The time gears now being properly set, the exhaust valve on No. 1 cylinder is open and the intake valve closed, the other valves being in the posi-

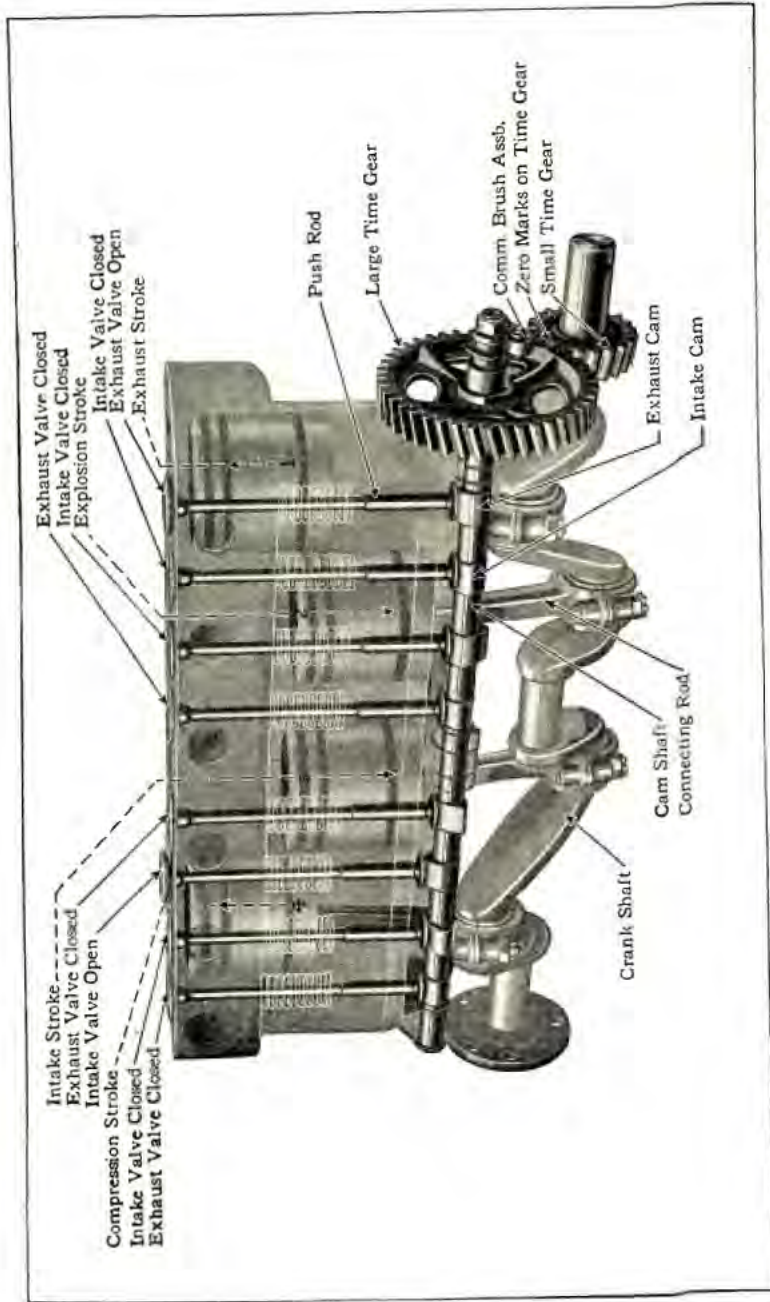

Cylinder Assembly, showing the correct position of the valves with time gears properly set according to punch marks on the gears, also the relative position of the pistons in their strokes as indicated above. The firing order of the cylinders is 1, 2, 4, 3. (Cut No. 2)

tion indicated in Cut No. 2. The opening and closing of the valves being as follows: The exhaust valve opens when the piston reaches 5-16" of bottom center, the distance from the top of the piston head to the top of cylinder casting measuring 3 3-8". The exhaust valve will close on top center, the piston being 5-16" above the cylinder casting. The intake valve opens 1-16" after top center, and closes 9-16" after bottom center, the distance from the top of the piston to the top of the cylinder casting measuring 3 1-8".

#### What about the care of the Valves?

They seldom get out of order—but they do get dirty, as a result of carbon collecting on the valve seats. These carbon deposits, by preventing proper closing of the valves, permit the gases under compression to escape, resulting in loss of power and uneven running of the motor. If, when turning the engine over slowly, there is a lack of resistance in one or more cylinders, it is probable that the valves need re-grinding. As the "life" of the engine depends largely upon the proper seating of the valves, it is necessary that they be ground occasionally.

#### Answer No. 23

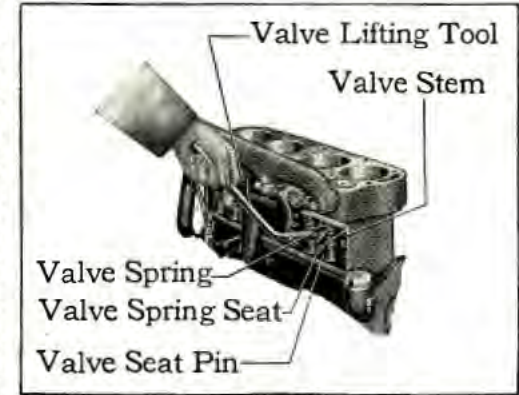

How the valve lifting tool should be used. (Cut No. 3)

#### How are Valves removed for grinding?

(1) Drain radiator; (2) remove cylinder head; (3) remove the valve cover on the right side of engine; (4) raise the valve spring with lifting tool (see Cut No. 3) and pull out the valve seat pin that is in the valve stem. The valve may then be lifted out by the head.

#### Answer No. 24

#### How are Valves ground?

For this work use a good valve grinding compound. A convenient way is to put a small amount in a suitable dish, adding a spoonful or two of kerosene and a few drops of lubricating oil to make a thin paste.

Place the mixture sparingly on the bevel face of the valve. Put the valve in position on the valve seat, and rotate it back and forth (about a quarter turn) a few times, with a Ford grinding tool. Then lift slightly from the seat, change the position and continue the rotation, and keep on repeating this operation until the bearing surface is smooth and bright. The valve should not be turned through a complete revolution, as this is apt to cause scratches running around the entire circumference of the valve and seat. When the grinding is completed the valve should be removed from the cylinder, thoroughly washed with kerosene, and the

#### Answer No. 25



valve seat wiped out thoroughly. Extreme care should be taken that no abrasive substance gets into the cylinders or valve guides. This can be avoided if the grinding paste is applied sparingly to the bevel face of the valve.

If the valve seat is badly worn or pitted, it is best to have it reseated with a valve seating tool. This operation requires considerable skill, and perhaps had better be done by an expert mechanic. Care should be exercised against making too deep a cut, necessitating the retiming of the valve.

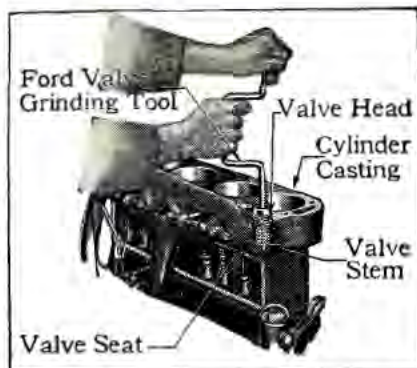

Method of grinding valve. (Cut No. 4)

**When the Valves and Push Rods are worn—what?**

**Answer No. 26**

When the valves or push rods become worn, so as to leave too much play between them, thus reducing the lift of the valves and diminishing the power of the motor, it is best to install new push rods. If replacing the push rod does not give the desired clearance, the valve should also be replaced.

Installation of new push rods or valves necessitates retiming the motor (See Answer No. 22.)

**What about the Valve Springs?**

**Answer No. 27**

When the valves fail to seat themselves properly, there is a possibility that the springs may be weak or broken. Weakness in the exhaust valve spring causes a very uneven action. The symptoms are a lag in the engine due to the exhaust valve not closing instantaneously, and as a result a certain percentage of the charge under compression escapes, greatly diminishing the force of the explosion. Weakness in a valve spring can usually be detected by the following method: Remove the plate which encloses them at the side of the cylinder and insert a screw-driver between the coils of the spring while the engine is running. If the extra tension thus produced causes the engine to pick up speed, the spring is obviously weak and should be replaced with a new one.

**What causes "Knocking" in the Engine?**

**Answer No. 28**

There are several causes, which may be enumerated as follows: (1) carbon knock—which is by far the most common—resulting from carbonizing of cylinders; (2) knock caused by a too advanced spark; (3) connecting rod knock; (4) crank shaft main bearing knock; (5) knock due to loose-fitting piston or broken ring; (6) knock caused by the piston striking the cylinder head gasket. When the engine knocks from any cause whatsoever, the matter should be promptly investigated by an experienced mechanic and the difficulty corrected.

**How may the different Knocks be distinguished?**

**Answer No. 29**

(1) The carbon knock is a clear, hollow sound, most noticeable in climbing sharp grades, particularly when the engine is heated. It is also indicated by a sharp rap immediately on advancing the throttle. (2) Too advanced spark will be indicated by a dull knock in the motor. (3) The connecting rod knock sounds like the distant tapping of steel with a small hammer, and is readily distinguished when the car is allowed to run idly down grade—or upon speeding the car to twenty-five miles an hour, then suddenly closing the throttle, the tapping will be very distinct. (4) The crank shaft main bearing knock can be distinguished, when the car is going uphill, as a dull thud. (5) The loose piston knock is heard only upon suddenly opening the throttle, when the sound produced might be likened to a rattle. The remedies for these knocks are treated under their proper division.

**How is carbon removed from Combustion Chamber?**

**Answer No. 30**

First, drain the water off by opening the pet cock at the bottom of the radiator; then disconnect the wires at the top of the motor and remove the spark coil; also disconnect the cylinder head outlet connection. Remove the 15 cap screws which hold the cylinder head in place. Take off the cylinder head and, with a putty knife or carbon scraper, scrape the carbonized matter from the cylinder head and top of pistons, being careful to prevent the specks of carbon from getting into the cylinders or bolt holes. In replacing the cylinder head gasket turn the motor over so that No. 1 and No. 4 pistons are at top center; place the gasket in position over the pistons and then put the cylinder head in place. Be sure and draw the cylinder head bolts down evenly (i. e., give each bolt a few turns at a time); do not tighten them on one end before drawing them up at the other. After the engine has warmed up the bolts should again be tightened.

**How are Spark Plugs cleaned?**

**Answer No. 31**

After removing the plug from the engine the points may be cleaned with an old tooth-brush dipped in gasoline. However, in order to do the work thoroughly, the plug should be taken apart by securing the large hexagon steel shell in a vise and loosening the pack nut which holds the porcelain in place. The carbon deposits can then be easily removed from the porcelain and shell with a small knife. Care should be exercised not to scrape off the glazed surface of the porcelain, otherwise it will be apt to carbonize quickly. The porcelain and other parts should finally be washed in gasoline and wiped dry with a cloth. In assembling the plug care should be taken to see that the pack nut is not tightened too much so as to crack the porcelain, and the distance between the sparking points should be  $\frac{1}{8}$ ", about the thickness of a smooth dime.

**How is the Power Plant removed from the Car?**

**Answer No. 32**

(1) Drain the radiator; disconnect inlet and outlet water connections; disconnect radiator stay rod at dash; remove stud nuts fastening radiator to frame, and remove radiator starting crank and radiator apron. (2) Shut off gasoline at sediment bulb; disconnect feed pipe at carburetor; remove carburetor adjusting rods, priming rods and pull rod. (3) Disconnect steering gear arm and bracket; disconnect steering gear post at dash and instrument board; disconnect commutator pull rod and horn wires and move steering gear back.



- (4) Disconnect radius rod from crank case.
- (5) Disconnect all wires and remove coil box and spark plugs.
- (6) Remove engine pans and hood blocks.
- (7) Disconnect exhaust pipe from manifold.
- (8) Remove four bolts at universal joint housing, two bolts from each crank case arm and two cap screws at crank case front bearing.
- (9) Pass a rope around the engine, placing the rope behind the two radius rod studs and between starting motor and cylinder block, tying the ends of the rope securely at top of engine. Pass a 2" x 4" or a stout iron pipe about ten feet long through the loop in the rope, and with a man at each end of the "2 x 4" or pipe and another holding the starting crank handle, the engine can be lifted from the car.

### **Connecting Rod Bearings —how adjusted?**

### **Answer No. 33**

Connecting rod bearings may be adjusted, without taking out the engine, by the following method: (1) drain off the oil; (2) remove plate on bottom of crank case—exposing connecting rods; (3) take off first connecting rod cap, and draw-file the ends—a very little at a time; (4) replace cap, being careful to see that file marks correspond, and tighten bolts until cap fits shaft snugly; (5) test tightness of bearing by turning engine over by the starting handle. Experienced mechanics usually determine when the bearing is properly fitted by lightly tapping each side of the cap with a hammer; (6) then loosen the bearing and proceed to fit the other bearings in the same manner; (7) after each bearing has been properly fitted and tested—then tighten the cap bolts and insert cotter pins and the work is finished.

Remember, there is a possibility of getting the bearings too tight, and under such conditions the babbitt is apt to cut out quickly, unless precaution is taken to run the motor slowly at the start. It is a good plan after adjusting the bearings to jack up the rear wheels and let the motor run slowly for about two hours (keeping it well supplied with water and oil) before taking it out on the road. Whenever possible these bearings should be fitted by an expert Ford mechanic.

Worn connecting rods may be returned, prepaid, to the nearest dealer for exchange at a price of \$0.60 each to cover the cost of rebabbitting. It is not advisable for any owner or repair shop to attempt the rebabbitting of connecting rods or main bearings, for without a special jig in which to form the bearings, satisfactory results will not be obtained. The constant tapping of a loose connecting rod on the crank shaft will eventually produce crystallization of the steel—result, broken crank shaft and possibly other parts of the engine damaged.

### **Crank Shaft Main Bearings How adjusted?**

### **Answer No. 34**

Should the main bearings in which the crank shaft revolves become worn (evidenced by a pounding in the engine) and need adjusting, proceed as follows:

- (1) Remove carburetor pull rod, cylinder valve cover and crank case lower cover.
- (2) To remove the rear main bearing cap, it is necessary to break the fly wheel cap screw wire and remove one of the fly wheel cap screws.
- (3) Remove rear bearing cap and one brass shim from each bolt.
- (4) Clean out any babbitt from oil grooves in bearing cap and cover surface of bearing with oil.
- (5) Replace cap, making sure it is installed in its original position.
- (6) Run down the two crankshaft bearing bolt nuts drawing them down tightly and lining up nut with cotter pin hole, so that cotter pin can be entered. In

locating the cotter pin hole, never turn the nut back. If the cotter pin hole in the bolt does not line up with the nut, run the nut back sufficiently far to insure a new setting, then draw nut down tightly, taking care not to pass cotter pin hole.

(7) Test for tightness of bearing by turning engine over slowly with starting crank (a slight increase in resistance should be noted).

(8) If bearing cap is still loose, remove another shim from each of the two bolts. If adjustment is too tight, replace the shim on one of the bolts, then run down the nuts and lock them with cotter keys.

(9) Replace flywheel cap screw, and fasten with lock wire.

(10) The center bearing is adjusted next, and the front bearing is adjusted last. These two bearings are adjusted in the same manner as the rear main bearing.

(11) Replace crank case lower cover, cylinder valve cover and carburetor pull rod.

*Note*—If with all shims removed, it is impossible to properly fit the bearing, the cap may be filed off, but in all probability the babbitt in the cylinder block has been worn to such an extent that the block should be re-babbitted.

## The Ford Cooling System

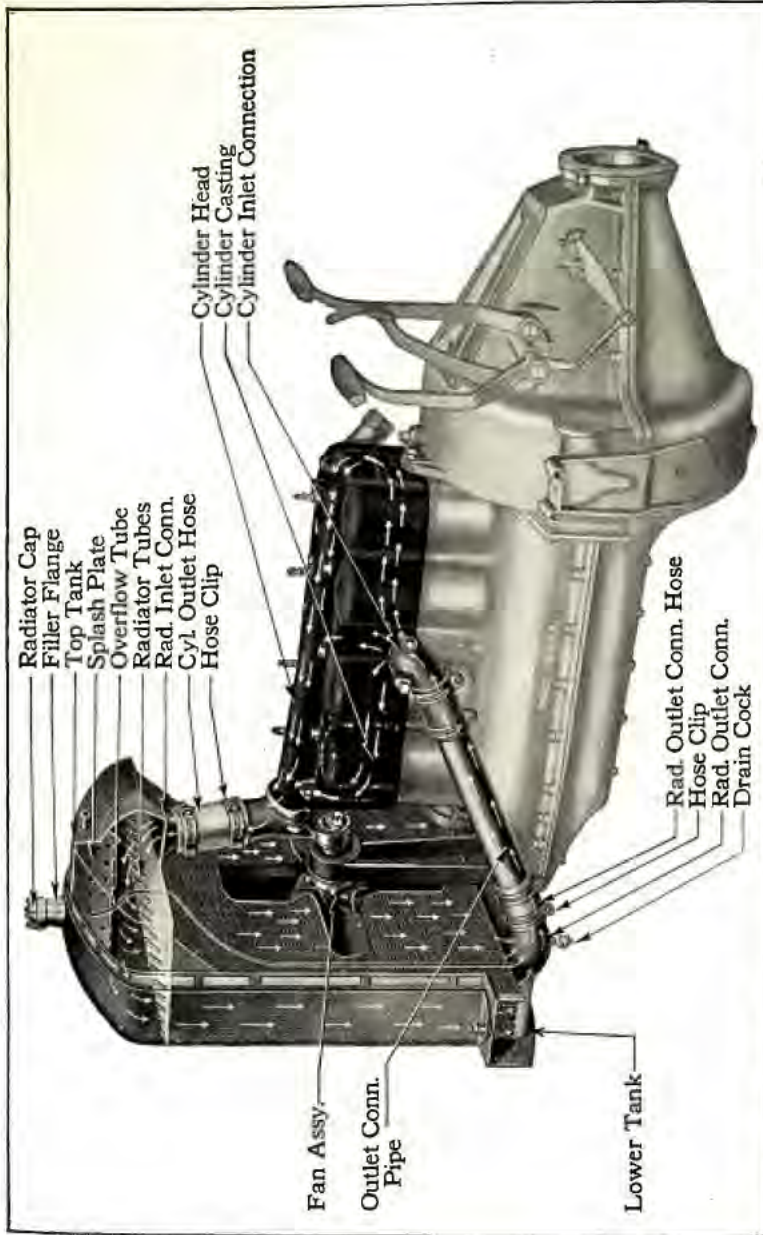

The Thermo-Syphon Cooling System, showing course of water through water passages. (Cut No. 5)

**How is the Engine cooled?**

**Answer No. 35**

The heat generated by the constant explosions in the engine would soon overheat and ruin the engine, were it not cooled by some artificial means. The Ford engine is cooled by the circulation of water in jackets around the cylinders. The heat is extracted from the water by its passing through the thin metal tubing of the radiator—to which are attached scientifically worked out fins, which assist in the rapid radiation of the heat. The fan, just back of the radiator, sucks the air around the tubing—around which the air is also driven by the forward movement of the car. The fan belt should be inspected occasionally and tightened when necessary—not too tight, however—by means of the eccentric adjustment in the fan bracket. Take up the slack till the fan starts to bind when turned by hand.

**How does the Water circulate?**

**Answer No. 36**

The cooling apparatus of the Ford car is known as the Thermo-syphon system. It acts on the principle that hot water seeks a higher level than cold water—consequently when the water reaches a certain heat, approximately 180 degrees Fahrenheit, circulation commences and the water flows from the lower radiator outlet pipe up through the water jackets, into the upper radiator water tank, and down through the tubes to the lower tank, to repeat the process.

**What are the causes of Overheating?**

**Answer No. 37**

(1) Carbonized cylinders; (2) too much driving on low speed; (3) spark retarded too far; (4) poor ignition; (5) not enough or poor grade oil; (6) racing motor; (7) clogged muffler; (8) improper carburetor adjustment; (9) fan not working properly on account of broken or slipping belt; (10) improper circulation of water due to clogged or jammed radiator tubes, leaky connections or low water.

**What should be done when the Radiator overheats?**

**Answer No. 38**

Keep the radiator full. Don't get alarmed if it boils occasionally—especially in driving through mud and deep sand or up long hills in extremely warm weather. Remember that the engine develops the greatest efficiency when the water is heated nearly to the boiling point. But if there is persistent overheating when the motor is working under ordinary conditions—find the cause of the trouble and remedy it. The chances are that the difficulty lies in improper driving or carbonized cylinders. By reference to the proper division of this book each of the causes which contribute to an overheated radiator is treated and remedies suggested. No trouble can result from the filling of a heated radiator with cold water—providing the water system is not entirely empty—in which case the motor should be allowed to cool before the cold water is introduced.

**How about cleaning the Radiator?**

**Answer No. 39**

The entire circulating system should be thoroughly flushed out occasionally. To do this open the pet cock at the bottom of the radiator and insert a hose into the filler neck, allowing the water to flow through the system for about fifteen or twenty minutes.



**Will the Radiator freeze in winter?****Answer No. 40**

Yes, unless an anti-freezing solution is used in the circulating system you are bound to experience trouble. As the circulation does not commence until the water becomes heated, it is apt to freeze at low temperatures before it commences to circulate. In case any of the radiator tubes happen to be plugged or jammed they are bound to freeze and burst open if the driver undertakes to get along without using a non-freezing solution. Wood or denatured alcohol can be used to good advantage. The following table gives the freezing points of solutions containing different percentages of alcohol:

20% solution freezes at 15 degrees above zero.

30% solution freezes at 8 degrees below zero.

50% solution freezes at 34 degrees below zero.

A solution composed of 60% water, 10% glycerine and 30% alcohol is commonly used, its freezing point being about 8 degrees below zero.

On account of evaporation fresh alcohol must be added frequently in order to maintain the proper solution.

**How are leaks and jams in the Radiator repaired?****Answer No. 41**

While the stopping of one tube does not seriously interfere with the circulation, it is bound to cause trouble sooner or later—and the tube will freeze in cold weather. Cut the tube an inch above and below the jam and insert a new piece, soldering the connections. If the entire radiator is badly jammed or broken it would probably be advisable to install a new one.

**The Gasoline System****The Carburetor—how does it work?****Answer No. 42**

The carburetor is of the automatic float feed type, having but one adjustment—the gasoline needle valve. The cross-section diagram of carburetor on page 20 shows how the gasoline enters the carburetor, is vaporized by a current of air and passes through the inlet pipe to the engine in the form of an explosive mixture. The gasoline, entering the bowl of the carburetor, gradually raises the float to a point where the inlet needle is forced upwards into its seat, thus cutting off the flow of gasoline. As the gasoline in the bowl recedes, the float lowers, allowing the needle to drop from its seat and the flow of gasoline is resumed. It is plain to see that a constant level of gasoline is maintained in the carburetor by the automatic action of float and needle. The quantity of gasoline entering into the mixture is governed by the needle valve (see Answer No. 45). The volume of gas mixture entering the intake pipe is controlled by opening and closing the throttle, according to the speed desired by the driver.

**Why is Carburetor adjustment placed on Instrument Board?****Answer No. 43**

For the convenience of the driver in adjusting the carburetor. After the new car has become thoroughly worked in, the driver should observe the angle of the carburetor adjusting rod at which the engine runs most satisfactorily. In cold weather it will probably be found necessary to turn the adjusting rod one-quarter turn to the left, particularly in starting a cold engine. As gasoline vaporizes readily in warm weather, the driver will find it economical to reduce the quantity of gasoline in the mixture by turning the adjusting rod to the right as far as possible without reducing speed. This is particularly true when taking long drives where conditions permit a fair rate of speed being maintained, and accounts for the excellent gasoline mileage obtained by good drivers.

**What is meant by a "lean" and a "rich" Mixture?****Answer No. 44**

A lean mixture has too much air and not enough gasoline. A rich mixture has too much gasoline and not enough air. A rich mixture will not only quickly cover the cylinders, pistons and valves with carbon, but will tend to overheat the cylinders, and is likewise wasteful of the fuel. It will often choke the engine and cause misfiring at slow speeds, although at high speeds the machine will run perfectly. The mixture should be kept as lean as possible without the sacrifice of any of the power of the motor. A lean mixture will often result in backfiring through the carburetor, for the reason that the gas burns slowly in the cylinder, and is still burning when the inlet valve opens again, which causes the gas in the intake to ignite. A rich mixture is shown by heavy, black exhaust smoke with a disagreeable smell. Proper mixture will cause very little smoke or odor.

**How is the Carburetor adjusted?****Answer No. 45**

The usual method of regulating the carburetor is to start the motor, advancing the throttle lever to about the sixth notch, with the spark retarded to about the fourth notch. The flow of gasoline should now be cut off by screwing the needle valve down to the right until the engine begins to misfire, then gradually increase the gasoline feed by opening the needle valve until the motor picks up and reaches its highest speed and no trace of black smoke comes from the exhaust.



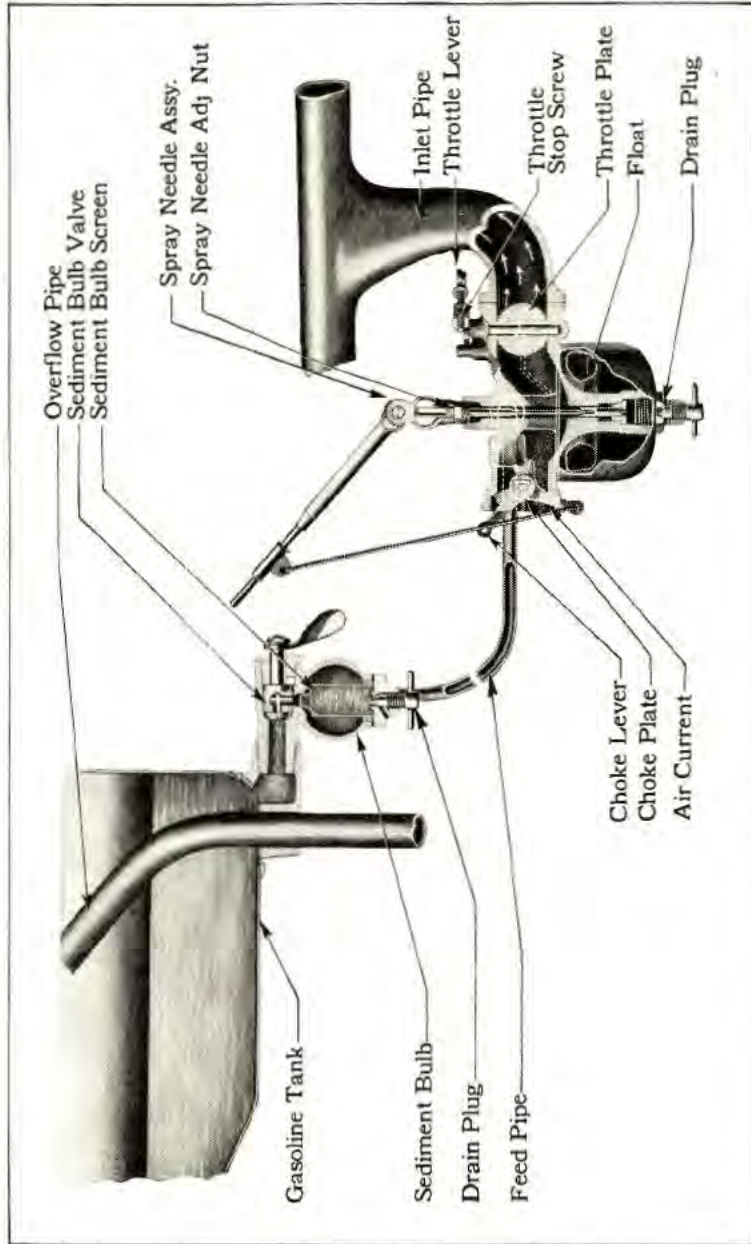

This cut illustrates the principle of Ford Carburetion. (Cut No. 6)

Use care in adjusting the carburetor as turning the needle down too tightly will result in its becoming grooved and the seat enlarged. When these parts are damaged it is difficult to maintain proper adjustment of the carburetor. For average running, a lean mixture will give better results than a rich one.

**Why does water clog the Carburetor?**

**Answer No. 46**

The presence of water in the carburetor or gasoline tank, even in small amounts, will prevent easy starting and the motor will misfire and stop. As water is heavier than gasoline it settles to the bottom of the tank and into the sediment bulb along with other foreign matter. As it is difficult nowadays to get gasoline absolutely free from impurities, especially water, it is advisable to occasionally drain the sediment bulb under the gasoline tank. During cold weather the water which accumulates in the sediment bulb is likely to freeze and prevent the flow of gasoline through the pipe leading to the carburetor. Should anything of this kind happen it is possible to open the gasoline line by wrapping a cloth around the sediment bulb and keeping it saturated with hot water for a short time. Then the water should be drained off. In event the water gets down into the carburetor and freezes, the same treatment may be applied.

**What makes the Carburetor leak?**

**Answer No. 47**

The flow of gasoline entering the carburetor through the feed pipe is automatically regulated by the float needle raising and lowering in its seat. Should any particle of dirt become lodged in the seat, which prevents the needle from closing, the gasoline will overflow in the bowl of the carburetor and leak out upon the ground.

**When there is dirt in the Carburetor—what?**

**Answer No. 48**

The spraying nozzle of the carburetor having a very small opening, a minute particle of grit or other foreign matter will clog up the orifice, and result: motor will begin to misfire and slow down as soon as it has attained any considerable speed. This is accounted for by the fact that at high speeds the increased suction will draw the particles of dust, etc., into the nozzle. By opening the needle valve half a turn and giving the throttle lever two or three quick pulls the dirt or sediment will often be drawn through, when the needle may be turned back to its original place. If this does not accomplish the purpose, the carburetor should be drained.

**If Engine runs too fast or chokes with throttle retarded—what?**

**Answer No. 49**

If the engine runs too fast with the throttle fully retarded unscrew the carburetor throttle lever adjusting screw until the engine idles at suitable speed. If the motor chokes and stops when throttle is fully retarded the adjusting screw should be screwed in until it strikes the boss, preventing the throttle from closing too far.

**What is the purpose of the Hot Air Pipe?**

**Answer No. 50**

It takes the hot air from around the exhaust pipe and conducts it to the carburetor—where the heat facilitates the vaporizing of the gasoline.



**What is the purpose of the Float?****Answer No. 51**

It automatically controls the flow of the gasoline into the carburetor. If it floats too low, starting will be difficult; if too high, the carburetor will flood and leak.

**Should Priming Rod be used in starting when Motor is warm?****Answer No. 52**

No. The carburetor does not ordinarily require priming when the motor is warm, and starting with the rod pulled out is apt to "flood" the engine with an over-rich mixture of gas, which does not readily explode. This naturally causes difficulty in starting. If you should accidentally flood the engine, turn the carburetor adjusting needle down (to the right) until it seats; then turn the engine over a few times in order to exhaust the rich gas. As soon as the motor starts, turn back the needle (to the left) and readjust the carburetor.

**The Ford Ignition System****What is the purpose of the Ignition System?****Answer No. 53**

It furnishes the electric spark which explodes the charge in the combustion chamber, thus producing the power which runs the engine. It is important that the charge be correctly ignited at the proper time, in order to obtain satisfactory results in running the car. In the Ford car the ignition system is as simple as it is possible to make it.

**How does the Magneto generate current?****Answer No. 54**

When the engine is running, the magnets attached to the fly wheel, pass the coil spools on the magneto coil assembly creating an alternating low tension current in the magneto coil. This current is carried from this magneto coil to the coil box through the magneto contact assembly and magneto wires.

**Should the Coil Vibrator Adjustment be disturbed?****Answer No. 55**

The present style of coil unit is properly adjusted when it leaves the factory and this adjustment should not be disturbed unless to install new points. When adjustments are necessary they should, whenever possible, be made by one of our service stations who have special equipment for testing and adjusting units and will gladly furnish expert service.

**How is a Weak Unit detected?****Answer No. 56**

With the vibrators properly adjusted, if any particular cylinder fails or seems to develop only a weak action, change the position of the unit to determine if the fault is actually in the unit. The first symptom of a defective unit is the buzzing of the vibrator with no spark at the plug. Remember that a loose wire connection, faulty spark plug, or worn commutator may cause irregularity in the running of the motor. These are points that should be considered before laying the blame on the coil.

**How may short circuit in Commutator Wiring be detected?****Answer No. 57**

Should the insulation of the primary wires (running from coil to commutator) become worn to such an extent that the copper wire is exposed—the current will leak out (i. e., short circuit) whenever contact with the engine pan or other metal parts is made. A steady buzzing of one of the coil units will indicate a "short" in the wiring. When driving the car the engine will suddenly lag and pound on account of the premature explosion. Be careful not to crank the engine downward against compression when the car is in this condition, as the "short" is apt to cause a vigorous "back kick."

**Does Coil Adjustment affect starting?****Answer No. 58**

Yes. When the vibrators are not properly adjusted more current is required to make and break the contact between the points, and, as a result, at cranking

speeds you would not get a spark between the spark plug points. Do not allow the contact points to become "ragged," otherwise they are apt to stick and cause unnecessary difficulty in starting, and when running they are apt to produce an occasional "miss" in the engine.

*What is the purpose of the Commutator?*

**Answer No. 59**

The commutator (or timer) determines the instant at which the spark plugs must fire. It effects the "make and break" in the primary circuit. The grounded wire in the magneto allows the current to flow through the metal parts to the metal roller in the commutator. Therefore, when the commutator roller in revolving touches the four commutator contact points, to each of which is attached a wire

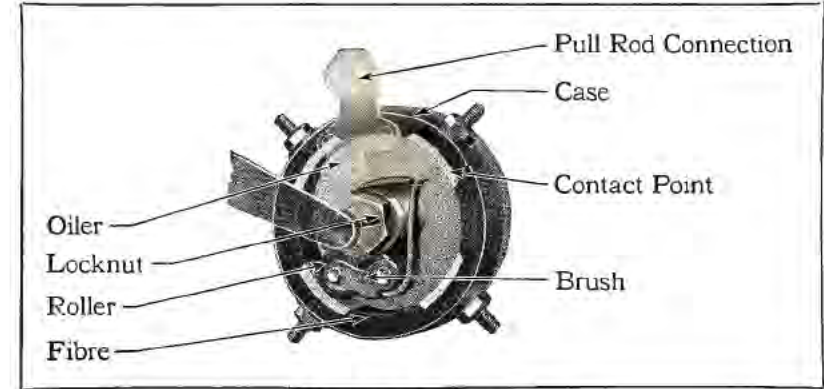

The Ford Commutator  
(Cut No. 8)

connected with a coil unit, an electrical circuit is passed through the entire system of primary wires. This circuit is only momentary, however, as the roller passes over the contact point very rapidly and sets up the circuit in each unit as the roller touches the contact point connected with that unit. The commutator should be kept clean and well oiled at all times.

*What about the Spark Plugs?*

**Answer No. 60**

One is located at the top of each cylinder and can easily be taken out with the spark plug wrench included with every car, after the wire is disconnected. The high voltage current flows out of the secondary coils in the coil box and on reaching the contact points in each spark plug it is forced to jump a  $\frac{1}{32}$ " gap, thereby forming a spark which ignites the gasoline charge in the cylinders.

The spark plugs should be kept clean (i. e., free from carbon) and should be replaced if they persist in not working properly. There is nothing to be gained by experimenting with different makes of plugs. The make of plugs with which Ford engines are equipped when they leave the factory are best adapted to the requirements of our motor, notwithstanding the opinion of various garage men to the contrary. All wire connections to spark plugs, coil box and commutator should, of course, at all times be kept in perfect contact.

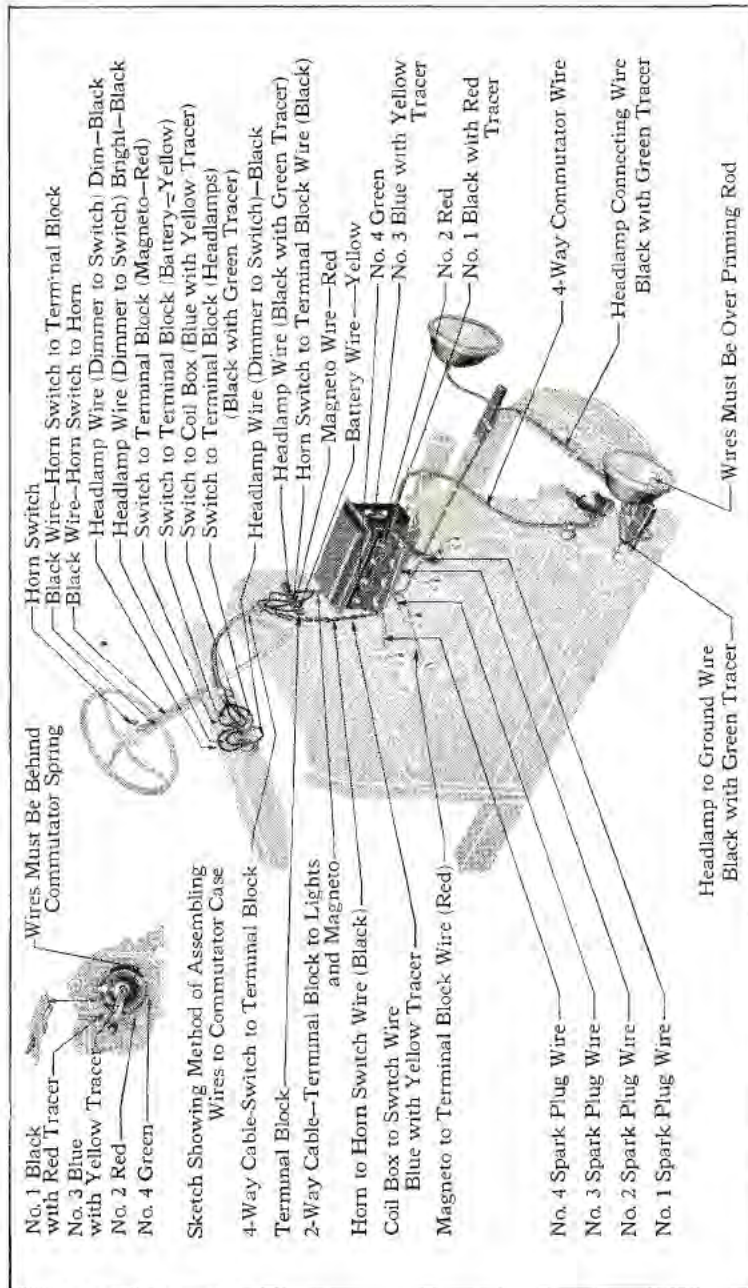

Wiring of Ford Ignition System. (Cut No. 7)



**What are the indications of Ignition trouble?**

**Answer No. 61**

The uneven sputter and bang of the exhaust means that one or more cylinders are exploding irregularly or not at all, and that the trouble should be promptly located and overcome. Misfiring, if allowed to continue, will in time damage the engine and the entire mechanism. If you would be known as a good driver you will be satisfied only with a soft, steady purr from the exhaust. If anything goes wrong, stop and fix it if possible—don't wait until you get home.

**How can one tell which Cylinder is missing?**

**Answer No. 62**

This is done by manipulating the vibrators on the spark coils. Open the throttle until the engine is running at a good speed and then hold down the two outside vibrators, No. 1 and No. 4, with the fingers, so they cannot buzz. This cuts out the two corresponding cylinders, No. 1 and No. 4, leaving only No. 2 and No. 3 running. If they explode regularly it is obvious the trouble is in either No. 1 or No. 4. Relieve No. 4 and hold down No. 2 and No. 3 and also No. 1; if No. 4 cylinder explodes evenly it is evident the misfiring is in No. 1. In this manner all of the cylinders in turn can be tested until the trouble is located. Examine both the spark plug and the vibrator of the missing cylinder.

**If the Coil and Plug are right—what?**

**Answer No. 63**

The trouble is probably due to an improperly seated valve, worn commutator, or short circuit in the commutator wiring. Weakness in the valves may be easily determined by lifting the starting crank slowly the length of the stroke of each cylinder in turn, a strong or weak compression in any particular valve being easily detected. It sometimes happens that the cylinder head gasket (packing) becomes leaky—permitting the gas under compression to escape, a condition that can be detected by running a little lubricating oil around the edge of the gasket and noticing whether bubbles appear or not.

**Does a worn Commutator ever cause misfiring?**

**Answer No. 64**

Yes. If misfiring occurs when running at high speed, inspect the commutator. The surface of the circle around which roller (see Cut No. 8) travels should be clean and smooth, so that the roller makes a perfect contact at all points. If the roller fails to make a good contact on any one of the four contact points, its corresponding cylinder will not fire. Clean these surfaces, if dirty. In case the contact points and roller of the commutator are badly worn the most satisfactory remedy is to replace them with new parts. The spring should be strong enough to make a firm contact against the roller points.

Misfiring may also be caused by short circuited commutator wires.

**How is the Commutator removed?**

**Answer No. 65**

Remove cotter pin from spark rod and detach latter from commutator. Loosen the cap screw which goes through breather pipe on top of time gear cover. This will release the spring which holds the commutator case in place and this part can be readily removed. Unscrew lock nut; withdraw steel brush cap and remove the retaining pin. The brush can then be removed from the cam shaft.

**Does cold weather affect the Commutator?**

**Answer No. 66**

It is a well-known fact that in cold weather even the best grades of lubricating oil are apt to congeal to some extent. If this occurs in the commutator it is very apt to prevent the roller from making perfect contact with the contact points imbedded in the fibre. This, of course, makes difficult starting as the roller arm spring is not stiff enough to brush away the film of oil which naturally forms over the contact points. To overcome this, as well as any liability of the contact points to rust, we recommend a mixture of kerosene with commutator lubricating oil, which will thin it sufficiently to prevent congealing, or freezing, as it is commonly called. You have probably noticed in starting your car in cold weather that perhaps only one or two cylinders will fire for the first minute or so, which indicates that the timer is in the condition described above and as a consequence a perfect contact is not being made on each of the four terminals.

**How is the Magneto removed?**

**Answer No. 67**

It is necessary to take the power plant out of the car (see Answer No. 32) in order to remove the magneto. Then remove crank case and transmission cover—take out the four cap screws that hold the flywheel to the crank shaft. You will then have access to the magnets and entire magneto mechanism. In taking out these parts—or any parts of the car—the utmost care should be taken to make sure that the parts are so marked that they may be replaced properly.

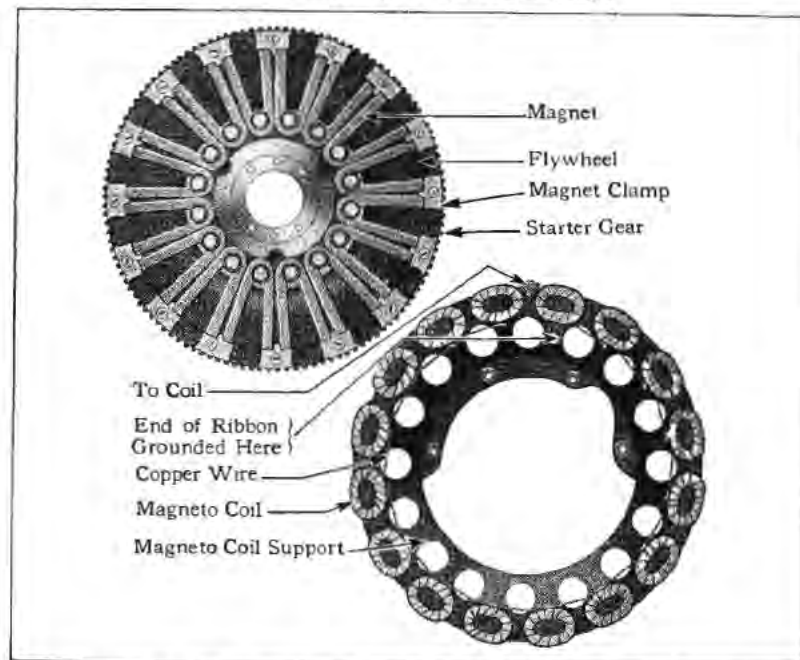

The Ford Magneto. The flywheel with magnets revolves while magneto coils remain stationary. (Cut No. 9)



**When the Magneto gets out of order—what?****Answer No. 68**

The Ford magneto is made of permanent magnets and there is very little likelihood of their ever losing their strength, unless acted upon by some outside force. For instance, the attachment of a storage battery to the magneto terminal will demagnetize the magnets. If anything like this happens, it is not advisable to try to recharge them, but rather install a complete set of new magnets. The new magnets may be obtained from the nearest Ford Dealer, placed on a board in identically the same manner as they should be when installed on the flywheel. Great care should be taken in assembling the magnets and lining up the magneto so that the faces of the magnets are separated from the surface of the coil spool just  $\frac{1}{32}$  of an inch. To take out the old magnets, simply remove the cap screws and brass screws which hold them in place. The magneto is often blamed when the trouble is a weak current caused by waste or other foreign matter accumulating under the contact spring, which is held in place by the binding post on top of the transmission cover. Remove the binding post and spring and replace after foreign substance has been removed.

**The Ford Transmission****What is the function of the Transmission?****Answer No. 69**

It is that part of the mechanism of an automobile which lies between the crank shaft and the drive shaft and by which one is enabled to move at different speeds from the other. It is the speed gear of the car. It permits driving the car forward at low and high speeds and by it the car is reversed.

**What is meant by the term "Planetary Transmission?"****Answer No. 70**

One in which the groups of gears always remain in mesh and revolve around a main axis. The different sets of gears are brought into action by stopping the revolution of the parts which support the gears. By means of bands (similar to brake bands) the rotation of the different parts is stopped. The planetary transmission is the simplest and most direct means of speed control—and is a distinct advantage of the Ford car.

**What is the purpose of the Clutch?****Answer No. 71**

If the crank shaft of the engine ran without break straight through to the differential—and through it applied its power direct to the rear wheels—the car would start forward immediately upon the starting of the engine (were it possible to get it started under such conditions). To overcome this difficulty the shaft is divided and by means of the clutch the part of the shaft to which the running engine is delivering its power is enabled to take hold of the unmoving part gradually and start the car without jolt or jar. The forward part of the assembly is referred to as the crank shaft, the rear part as the drive shaft.

**How is the Clutch controlled?****Answer No. 72**

By the left pedal at the driver's feet (see Answer No. 10). If the clutch pedal, when pushed forward into slow speed, has a tendency to stick and not come back readily into high, tighten up the slow speed band as directed in Answer No. 74. Should the machine have an inclination to creep forward when cranking, it indicates that the clutch lever screw which bears on the clutch lever cam has worn, and requires an extra turn to hold the clutch in neutral position. When the clutch is released by pulling back the hand lever the pedal should move forward a distance of  $1\frac{3}{4}$ " in passing from high speed to neutral. See that the hub brake shoe and connections are in proper order so that the brake will prevent the car creeping ahead. Also be sure the slow speed band does not bind on account of being adjusted too tight. Don't use a too heavy grade of oil in cold weather as it will have a tendency to congeal between the clutch discs and prevent proper action of the clutch when starting the engine.

**How is the Clutch adjusted?****Answer No. 73**

Remove the plate on the transmission cover under the floor boards at the driver's feet. Take out the cotter key on the first clutch finger and give the set screw one-half to one complete turn to the right with a screw-driver. Do the same to the other finger set screws. But be sure to give each finger the same number of turns and don't forget to replace the cotter keys after each finger has been adjusted.



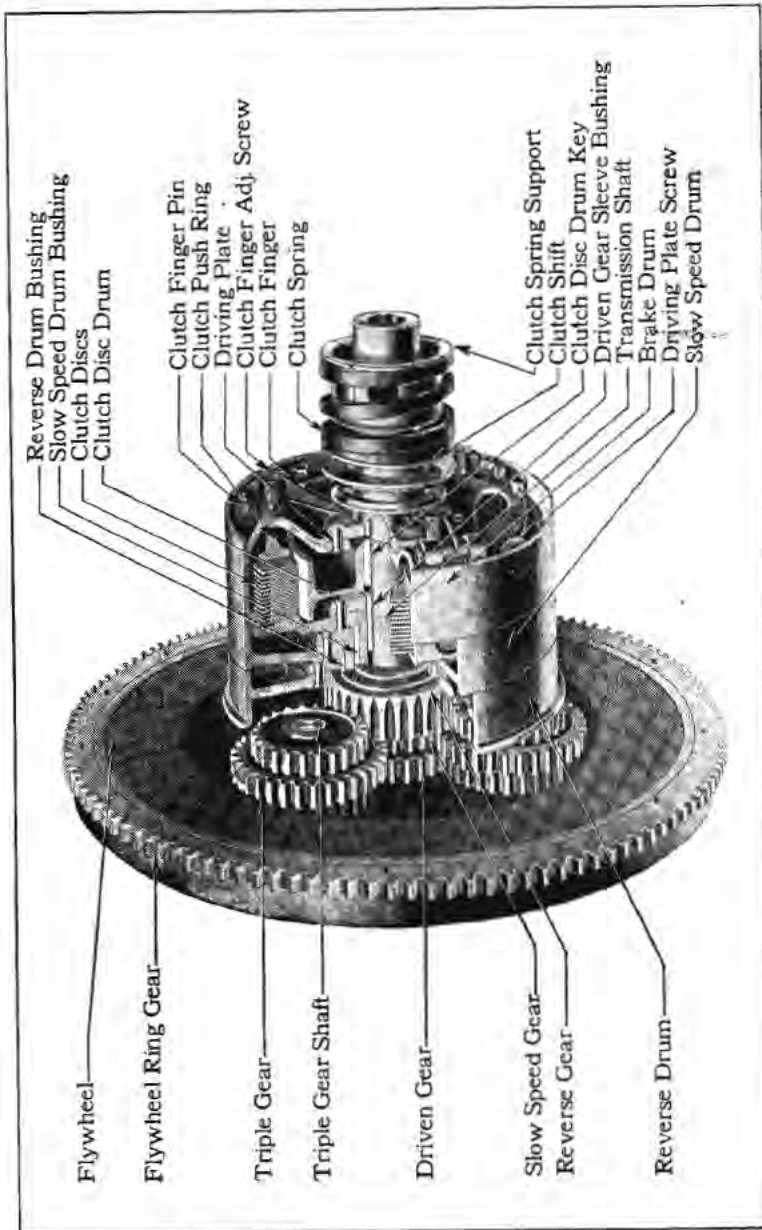

Transmission showing all gears in mesh. (Cut No. 10)

**CAUTION:** Let us warn you against placing any small tools or objects over or in the transmission case without a good wire or cord attached to them. Otherwise if they are dropped into the transmission case it is almost impossible to recover them without taking off the transmission cover.

#### How are the Bands adjusted?

#### Answer No. 74

The slow speed band may be tightened by loosening the lock nut at the right side of the transmission cover, and turning the adjusting screw (see Cut No. 11) to the right. To tighten the brake and reverse bands remove the transmission cover door and turn the adjusting nuts on the shafts to the right. See that the bands do not drag on the drums when disengaged, as they exert a brake effect, and tend to overheat the motor. However, the foot brake should be adjusted so that a sudden pressure will stop the car immediately, or slide the rear wheels in case of emergency. The bands, when worn to such an extent that they will not take hold properly, should be relined, so that they will engage smoothly without causing a jerky movement of the car. The lining is inexpensive and may be had at any Ford service station at small cost.

#### How are the Bands removed?

#### Answer No. 75

To remove the transmission bands, remove the transmission cover door. Run off the nuts and lock washers from the ends of the pedal shafts, run out slow speed adjusting screw, and remove springs.

**"EXTREME CARE SHOULD BE EXERCISED TO PREVENT DROPPING ANY PARTS INTO THE TRANSMISSION."**

The reverse pedal and brake pedal should then be withdrawn as far as possible, and the detachable ears removed. To remove the ear, simply insert a tool (a screw driver with the end bent over approximately one-quarter inch) through the end of the ear into a square hole in the end of the transmission band and lift up on the tool, forcing the band down and the ear back. The bands may then be withdrawn from the right side, permitting them to follow close to the cover to prevent their being distorted.

To replace the bands, insert the plain end in the right side of the transmission cover, forcing the band around until it is possible to reach the square hole with the hooked tool. When the end of the band has been pulled around, the ear may be slipped over the studs and forced forward into the locked position, if necessary forcing it forward with the hooked tool.

The reverse band should be replaced first, the brake band second and the slow speed band last.

The slow speed adjusting screw, reverse and pedal shafts and transmission band springs are now reassembled, and the ears drawn into place, holding them against the compression of the spring with the hooked tool.

The lock washers and nuts may then be replaced and the bands adjusted in the regular way.

#### How is the Transmission assembled?

#### Answer No. 76

Cut No. 12 shows the transmission parts in their relative assembling positions and grouped in their different operations of assembling.

The first operation is the assembling of group No. 2, which is as follows: Place the brake drum on table with the hub in a vertical position, place the slow speed plate over the hub with gear uppermost. Then place reverse drum over the slow speed drum so that the reverse gear surrounds the slow speed gear. Fit the two



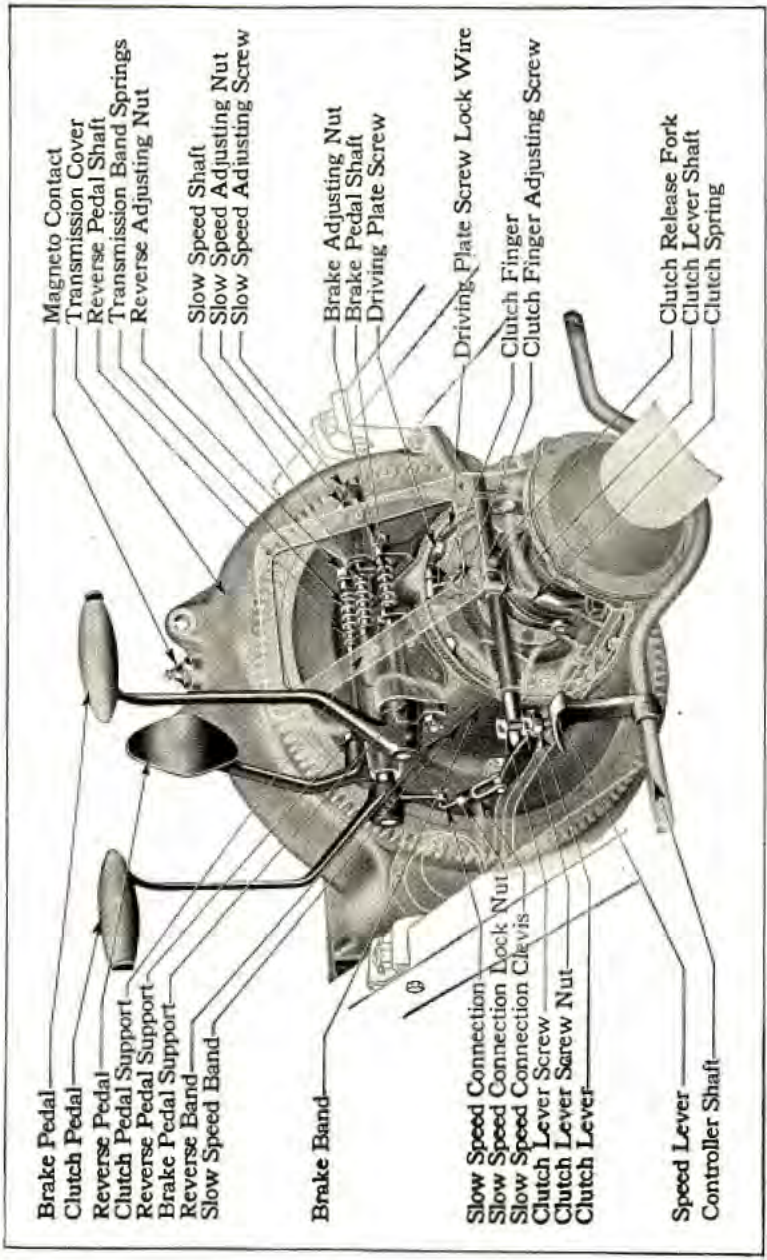

The above drawing of Transmission shows clearly the operation of Clutch, Reverse and Brake Pedals. (Cut. No. 11)

## Always Insist Upon Genuine Ford Parts

ONLY Genuine Ford parts should ever be used in repairing Ford cars. Ford parts are specially designed and constructed to meet the various strains and stresses to which the car is subjected.

Genuine Ford parts are sold at prices as low as is consistent with high quality. It is false economy to buy imitation parts at cheap prices both from a standpoint of serviceability and the possibility of endangering life and limb as a result of using inferior materials.

If you do not do your own repairing, make sure that genuine Ford parts are used in repairing your car by taking it to an authorized Ford dealer or service station to have the work done.

Dealers will exchange the following Model T parts with owners at the prices quoted below:

- Connecting Rods (Light type) .\$.60 each
- Magnets . . . . . 1.75 per set
- \*Magneto Coil . . . . . 3.00 each
- Generator Armature . . . . . 4.00 each
- Starting Motor Armature . . . . . 4.00 each

These prices are subject to revision without notice.

\* Does not apply to cars over one year old.



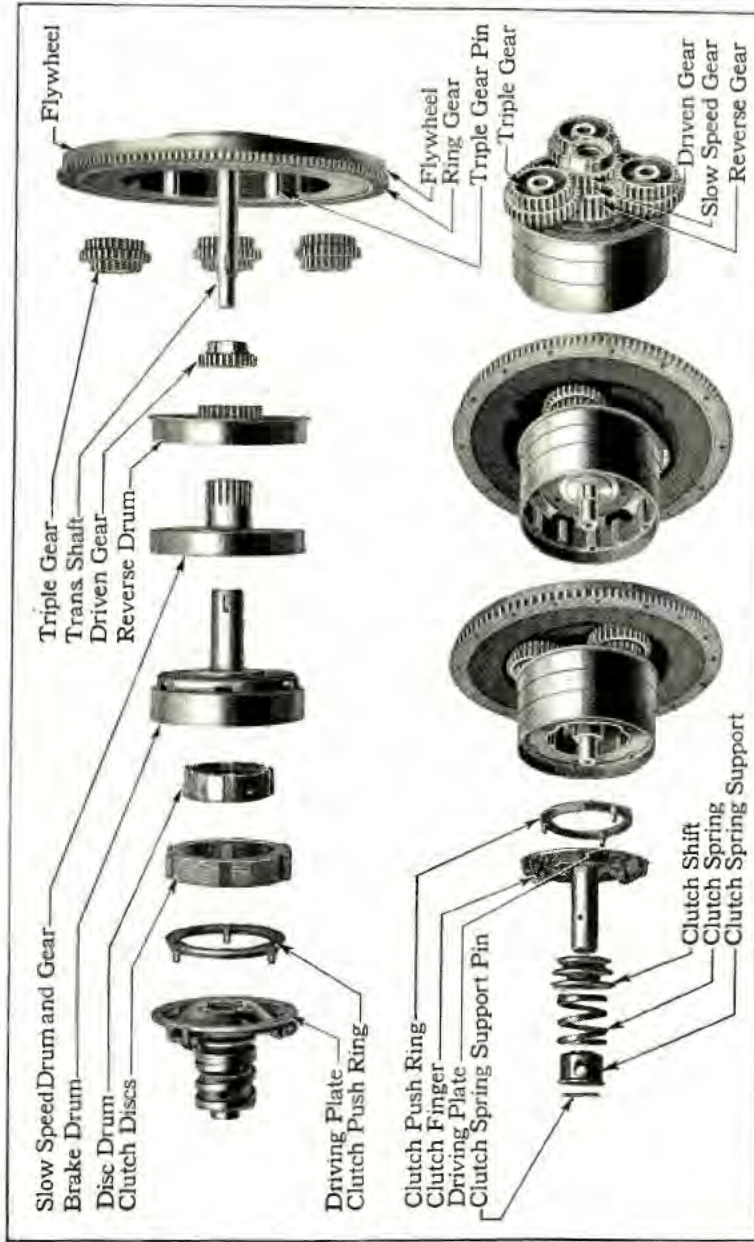

Transmission parts in their relative positions. (Cut No. 12)

keys in the hub just above the slow speed gear. Press the driven gear in position with the teeth downward so that they will come next to the slow speed gear. Take the three triple gears and mesh them with the driven gear according to the punch marks on the teeth, the reverse gear or smallest of the triple gear assembly being downward. After making sure that the triple gears are properly meshed tie them in place by passing a cord around the outside of the three gears. Take the flywheel and place it on the table with the face downward and the transmission shaft in a vertical position; then invert the group which you have assembled over the transmission shaft, setting it in position so that the triple gear pins on the flywheel will pass through the triple gears. This will bring the brake drum on top in a position to hold the clutch plates, etc. The next step is to install the three washers and fit the clutch drum key in the transmission shaft. Press the clutch disc drum over the shaft and put the set screw in place to hold the drum, locking the screw with a cotter key. Put a large disc over the clutch drum, then a small disc, alternating with large and small discs until the entire set of discs are in position, ending with a large disc on top. If a small disc is on top it is liable to fall over the clutch drum in changing the speed from high to low and as a result you would be unable to change the speed back into high. Next put the clutch push ring over the clutch drum, and on top of the discs, with the three pins projecting upward (see Group No. 4, Cut No. 12). You will note the remaining parts are placed as they will be assembled. Next bolt the driving plate in position so that the adjusting screws of the clutch fingers will bear against the clutch push ring pins. Before proceeding further it would be a good plan to test the transmission by moving the drums with the hands. If the transmission is properly assembled they will revolve freely. The clutch parts may be assembled on the driving plate hub as follows: Slip the clutch shift over the hub so that the small end rests on the ends of the clutch fingers. Next put on the clutch spring, placing the clutch support inside so that the flange will rest on the upper coil of the spring and press into place, inserting the pin in the driving plate hub through the holes in the side of the spring support. Then turn the clutch spring support until the pin fits into the lugs on the bottom of the support. The easiest method of compressing the spring sufficiently to insert the pin is to loosen the tension of the clutch fingers by means of the adjusting screws. When tightening up the clutch again, the spring should be compressed to within a space of two or two and one-sixteenth inches to insure against the clutch slipping. Care should be exercised to see that the screws in the fingers are adjusted so the spring is compressed evenly all around.

## The Rear Axle Assembly

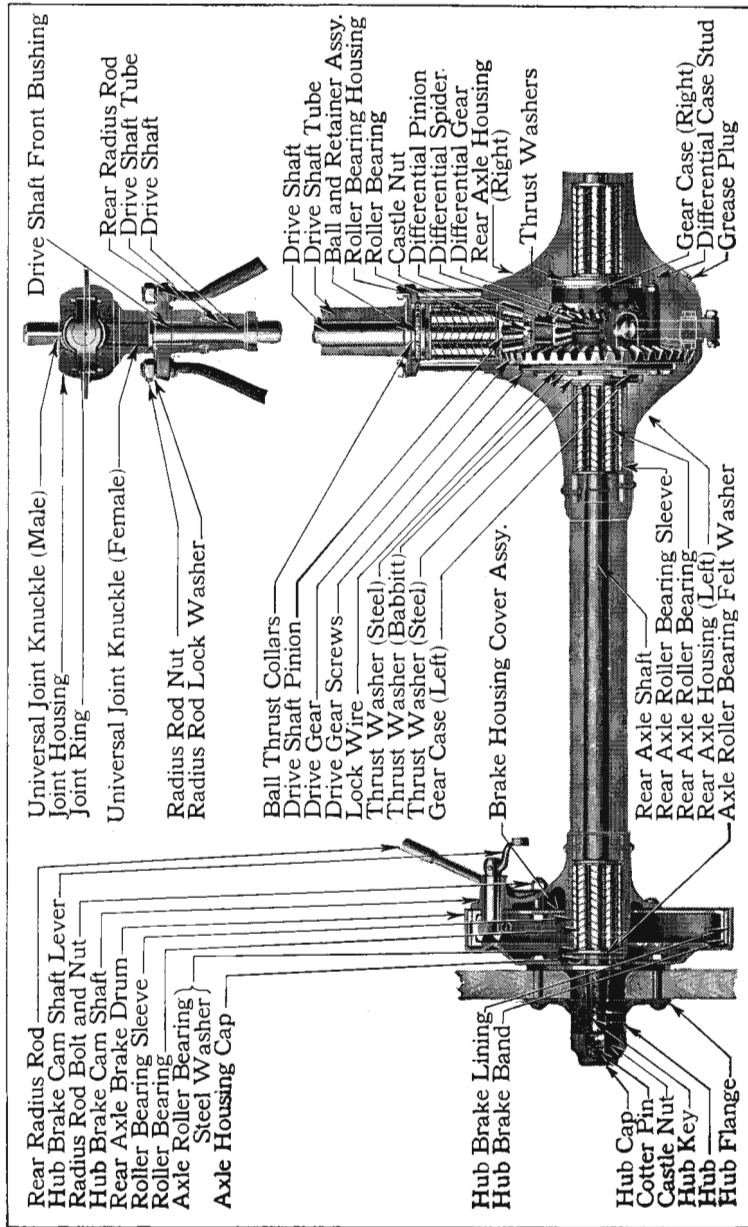

The Rear Axle System. (Cut No. 13)

**How is the Rear Axle removed?**

**Answer No. 77**

Jack up car and remove rear wheels as instructed in Answer No. 89. Take out the four bolts connecting the universal ball cap to the transmission case and cover. Disconnect brake rods. Remove nuts holding spring perches to rear axle housing flanges. Raise frame at the rear end, and the axle can be easily withdrawn.

**How is the Universal Joint disconnected from the Drive Shaft?**

**Answer No. 78**

Remove two plugs from top and bottom of ball casting and turn shaft until pin comes opposite hole, drive out pin and the joint can be pulled or forced away from the shaft and out of the housing.

**How are Rear Axle and Differential disassembled?**

**Answer No. 79**

Remove nuts on front end of radius rods and the cap screws holding drive shaft tube to rear axle housing. Remove bolts which hold the two halves of differential housing together. If necessary to disassemble differential a very slight mechanical knowledge will permit one to immediately discern how to do it once it is exposed to view. Care must be exercised to get every pin, bolt and keylock back in its correct position when reassembling.

**How is the Drive Shaft Pinion removed?**

**Answer No. 80**

The end of the drive shaft, to which the pinion is attached, is tapered to fit the tapered hole in the pinion, which is keyed onto the shaft, and then secured by a cotter-pinned "castle" nut. Remove the castle nut, and drive the pinion off.

**How is the Rear Axle Shaft removed?**

**Answer No. 81**

Disconnect rear axle as directed in Answer No. 77, then unbolt the drive shaft assembly where it joins the rear axle housing at the differential. Disconnect the radius rods and brake rods at the outer ends of the housing. Take out the bolts which hold the two halves of the rear axle housing together at the center and remove the housing. Take the inner differential casing apart and draw the axle shaft out.

After replacing the axle shaft be sure that the rear wheels are firmly wedged on at the outer end of the axle shaft and the key in proper position. When the car has been driven thirty days or so, make it a point to remove the hub cap and set up the lock nut to overcome any play that might have developed. It is extremely important that the rear wheels are kept tight, otherwise the constant rocking back and forth against the keyway may in time cause serious trouble.

If the rear axle or wheel is sprung by skidding against a curb, or other accident, it is false economy to drive the car without correcting the trouble, as tires, gears and all other parts will suffer. If the axle shaft is bent, it can, with proper facilities, be straightened, but it is best to replace it.



**How are the Differential Gears removed?**

**Answer No. 82**

The differential gears are attached to the inner ends of the rear axle shaft. They work upon the differential pinions when turning a corner, so that the axle shafts revolve independently, but when the car is moving in a straight line the differential pinions and differential gears and axle shafts move as an integral part. If you will examine the rear axle shafts you will notice that the gears are keyed on, and held in position by a ring which is in two halves and fits in a groove in the rear axle shaft. To remove the differential gears, force them down on the shaft, that is away from the end to which they are secured, drive out the two halves of ring in the grooves in shaft with screw-driver or chisel, then force the gears off the end of the shafts.

## The Ford Muffler

**Why is the Muffler necessary?**

**Answer No. 83**

The exhaust as it comes from the engine through the exhaust pipe would create a constant and distracting noise were it not for the muffler. From the comparatively small pipe, the exhaust is liberated into the larger chambers of the muffler, where the force of the exhaust is lessened by expansion and discharged out of the muffler with practically no noise. The Ford muffler construction is such that there is very little back pressure of the escaping gases, consequently there is nothing to be gained by putting a cut-out in the exhaust pipe between the engine and the muffler.

**How is the Muffler disconnected?**

**Answer No. 84**

Disconnect the exhaust pipe from the motor by unscrewing the pack nut and remove the bolt which holds the muffler to the frame. After the muffler has been disconnected it can be disassembled by removing the nut at the rear end of the muffler.

## The Running Gear

**What care should the Running Gear have?**

**Answer No. 85**

In the first place it at all times should have proper lubrication (see chapter on Lubrication). Once in every thirty days the front and rear axles should be carefully gone over to see that every moving part, such as the bushings in spring connections, spring hangers, steering knuckles and hub bearings, are thoroughly lubricated, and that all nuts and connections are secured with cotter pins in place. The spring clips, which attach the front spring to the frame, should be inspected frequently to see that everything is in perfect order.

**How is the front Axle Assembly Removed?**

**Answer No. 86**

Disconnect radius rod at the crank case and disconnect the steering gear arm from the steering gear post. Raise the front end of the car and remove the wheels. Remove the two nuts from the ends of the front spring clip and remove the license bracket and spring clip bar. The axle can then be easily removed from the car.

**In case of accident, how is the Front Axle straightened?**

**Answer No. 87**

Should the axle or spindle become bent extreme care must be used to straighten the parts accurately. Do not heat the forgings, as this will untemper the steel, but straighten them cold. If convenient it would be better to return such parts to the dealer, where they may be properly straightened in jigs designed for that purpose. It is very essential that the wheels line up properly (see Answer No. 91)

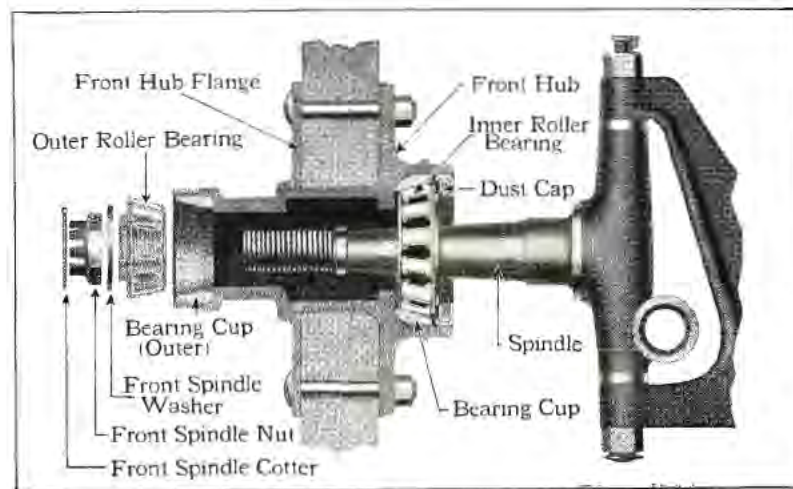

Sectional view of Hub showing Roller Bearings. (Cut No. 14)

The eye is not sufficiently accurate to determine whether the parts have been properly straightened, and excessive wear of the front tires will occur if everything is not in perfect alignment.



**What about the Front Wheels?****Answer No. 88**

The front wheels should be jacked up periodically and tested, not only for smoothness of running, but for side play as well. A wheel in perfect adjustment should, after spinning, come to rest with the tire valve directly below the hub. Undue wear of the hub bearings is usually caused by lack of lubrication and excessive friction, due to the adjusting cone being screwed up too tight. It is a good plan to clean the bearings frequently and keep the hub well filled with grease.

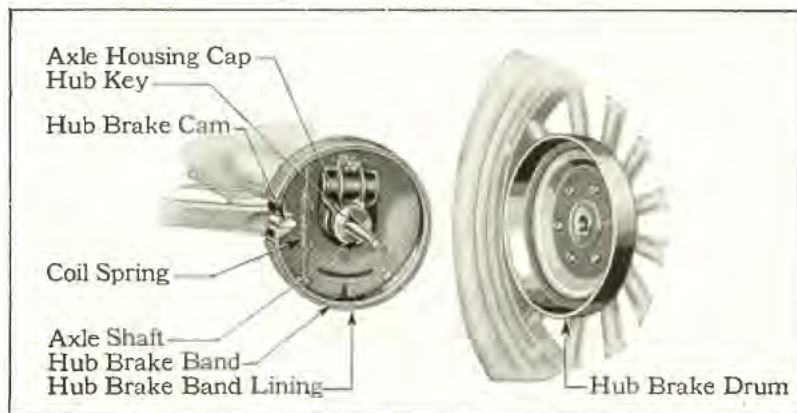

The Ford Emergency Brake. (Cut No. 15)

**How are the Wheels removed?****Answer No. 89**

**Front wheels:** Take off hub cap, remove cotter pin and unscrew castle nut and spindle washer. The adjustable bearing cone can then be taken out and the wheel removed. Care should be taken to see that the cones and lock nuts are replaced on the same spindle from which they were removed, otherwise there is a liability of stripping the threads which are left on the left spindle and right on the opposite as you stand facing the car. **Rear wheels:** Should removal of rear wheels be necessary, we strongly recommend that the work be done by a Ford dealer, as special equipment is necessary to satisfactorily perform this operation. However, if you find it absolutely necessary to remove the wheel yourself, proceed as follows: Take off hub cap, remove cotter pin and remove axle shaft nut; then with a wheel puller remove the wheel from the tapered shaft to which it is locked with a key. In replacing rear wheel be sure that nut on axle shaft is as tight as possible (using a wrench at least 24 inches long to provide necessary leverage) and put cotter pin in place. The hub caps of the rear wheels should be removed occasionally and the lock nuts which hold the hub in place tightened up. If these nuts are allowed to work loose, the resulting play on the hub key may eventually twist off the axle shaft.

**How are the Emergency Brake Shoes relined or replaced?****Answer No. 90**

Emergency brake shoes should be replaced or relined by a Ford dealer as special equipment is required to satisfactorily do this work. If, however, you find it absolutely necessary to do this work yourself, proceed as follows:

Remove the rear wheel as directed in answer No. 89 and disconnect brake shoe spring by withdrawing it from lug on brake shoe. After disconnecting the spring, the brake shoe can be lifted off of the axle brake housing plate.

New linings and rivets may be obtained from any Ford Dealer, and you can readily see how the lining is attached to the brake shoe.

To install the new brake shoe, position it on axle housing plate and insert the flange on the edge of the shoe behind the four steel clips on housing plate, lining it up so that hub brake cam can be entered between ends of brake shoe. Install brake shoe spring by placing it over lug on upper side of brake shoe and hooking it over the lower lug.

**How does the setting of the Front Wheels differ from that of the Rear Wheels?****Answer No. 91**

The front wheels are placed at an angle—that is to say, the distance between the tops of the front wheels is about three inches greater than between the bottoms. This is to give perfect steering qualities and to save wear on the tires when turning corners. The front wheels should also “toe-in” at the front—but not more than a quarter of an inch. All wheels should always be kept in proper alignment, otherwise steering will be difficult and tire wear greatly increased. Adjustment can be made by turning the yoke at the left end of the spindle connecting rod, to draw the wheels into a parallel position.

**What about installing Roller Bearing Cups?****Answer No. 92**

Whenever it is necessary to install roller bearing cups, the work should be done by a Dealer who has the necessary equipment for this work. In order to avoid excessive wear of the bearings it is essential that the cups be fitted absolutely true and this is practically impossible without the use of special equipment.

**How are the Roller Bearings installed?****Answer No. 93**

First, pack the hub full of clean good quality cup grease. Take the inner cone with its rollers and pack it with grease, filling all of the space around and between the rollers. Then place the inner cone in the larger cup. Next, drive the dust ring with felt washer into the inner end of the hub so that it is flush with the end of the hub.

Place the wheel carrying the inner bearings with dust ring on the spindle. The inner cone is a one-thousandth fit, or, in other words, a slip fit on the spindle. (See Cut No. 14.) It is never necessary to force the cone onto the spindle as the cups are forced into the hub. Pack the outer or threaded cone and rollers with cup grease, filling all the space between the rollers, as was done with the inner cone. The cones are made up in right- and left-hand threads to correspond to the threads on the spindles. Care should be taken that a right-hand threaded cone is not forced onto a left-hand threaded spindle. The right-hand thread is on the left-hand side of the car, while the left-hand thread is on the right-hand side of the car. Place the cone on the spindle, running it up tight enough so that the wheel seems to bind; give the wheel a few turns to be sure that all the working parts are in perfect contact; then back off the cone  $\frac{1}{4}$  to  $\frac{1}{2}$  a turn which will be sufficient to allow the wheel to revolve freely without end play. To determine if



there is end play, grasp the spokes and shake the wheel. Do not mistake loose spindle bushings for loose bearings. Insert a cold chisel between axle and spindle to take up any play while testing the bearings. Next, put on the spindle washer and nut, drawing the nut to a firm bearing. Make sure that the cone has not been forced out of adjustment. This can be determined by giving the wheel a few turns. Insert the cotter pin which locks the nut on the spindle, fill the hub cap with grease and screw it in place on the hub.

***How often should the Bearings be lubricated?***

***Answer No. 94***

Every three or four months the wheels should be removed, the old grease taken out and the hubs and bearings thoroughly cleansed with kerosene. Then repack the hub and bearings with clean grease and readjust the bearings.

***What care do the Springs need?***

***Answer No. 95***

The springs should be lubricated frequently with oil or graphite. To do this, pry the leaves apart near the ends and insert the lubricant between them. Whenever a car is given a general overhauling, the springs should be disassembled and the leaves polished with emery cloth, afterwards packing them with graphite when reassembling. Rust can be prevented from accumulating on the springs by painting them when necessary with a quick drying black paint. You will find that these suggestions if carried out will not only improve the riding qualities of the car but prolong the life of the parts as well.

***Should Spring Clips be kept tight?***

***Answer No. 96***

Yes. If the spring clips are allowed to work loose the entire strain is put on the tie bolt which extends through the centre of the spring. This may cause the bolt to be sheared off and allow the frame and body to shift a trifle to one side. It is a good plan to frequently inspect the clips which hold the springs to the frame and see that they are kept tight.

***What about the Steering Apparatus?***

***Answer No. 97***

It is exceedingly simple and will need little care—except, of course, proper lubrication. The post gears which are arranged in the “sun and planet” form are located at the top of the post just below the hub of the wheel (see Cut No. 1). By loosening the set screw and unscrewing the cap—after having removed the steering wheel—they may readily be inspected and replenished with grease. To remove the steering wheel, unscrew the nut on top of the post and drive the wheel off the shaft with a block of wood and hammer.

***How is Steering Gear tightened?***

***Answer No. 98***

Should the steering gear become loose, that is, so that a slight movement of the wheel does not produce immediate results, it may be tightened in the following manner: Disconnect the two halves of the ball sockets which surround the ball arm at the lower end of the steering post and file off the surface until they fit snugly around the ball. If the ball is badly worn it is best to replace it with a new one. Also tighten the ball caps at the other end of the steering gear connecting rod in the same manner. If the bolts in the steering spindle arms appear to be loose, the brass bushings should be replaced with new ones. Excessive play in the front axle may be detected by grasping one of the front wheels by the

spokes and jerking the front axle back and forth. After the car has been in service two or three years excessive play in the steering gear may make necessary the renewal of the little pinions, as well as the brass internal gear just underneath the steering wheel spider.

It is also advisable to inspect the front spring and front spring perches occasionally to determine whether or not new bushings are necessary to overcome any excessive vibration.

## The Ford Lubricating System

**How does the Ford Lubricating System differ from others?**

**Answer No. 99**

It is simplified—and there are fewer places to oil. Practically all of the parts of the engine and transmission are oiled by the Ford splash system, from the one big oil reservoir in the crank case. Cut No. 16 shows the principal points of lubrication, and specifies when replenishment should be made, according to mileage. This chart should be studied carefully and often. It is a good plan to frequently supply all oil cups with the same oil used in the engine (any good light grade lubricating oil will answer) and the dope cups with good grease. Be sure to see that the commutator is kept freely supplied with oil at all times.

**Which is the best way to fill the "Dope" Cups?**

**Answer No. 100**

When it is advisable to fill dope cup covers screw them down, refill with grease and repeat the operation two or three times. Occasionally remove front wheels and supply dope to wearing surface. A drop of oil now and then in crank-handle bearing is necessary, also on fan belt pulleys and shaft. The axles, drive shaft and universal joint are well supplied with lubricant when the car leaves the factory, but it is well to examine and oil them frequently.

**What kind of Oil should be used?**

**Answer No. 101**

We recommend only medium light high-grade gas engine oil for use in the Model T motor. A medium light grade of oil is preferred as it will naturally reach the bearings with greater ease and consequently less heat will develop on account of friction. The oil should, however, have sufficient body so that the pressure between the two bearing surfaces will not force the oil out and allow the metal to come in actual contact. Heavy and inferior oils have a tendency to carbonize quickly, also "gum up" the piston rings, valve stems and bearings. In cold weather a light grade of oil having a low cold test is absolutely essential for the proper lubrication of the car. Graphite should not be used as a lubricant in the engine or the transmission as it will have a tendency to short-circuit the magneto.

**How often should Oil be drained from Crank Case?**

**Answer No. 102**

It is advisable to clean out the crank case by draining off the dirty oil when the new car has been driven three hundred and fifty miles; thereafter it will only be necessary to repeat this operation about every seven hundred and fifty miles. Remove the plug underneath the flywheel casing and drain off the oil. It is desirable to occasionally flush the crank case by replacing the crankcase plug and putting two quarts of lubricating oil into the motor and running the engine slowly for a few minutes; then remove crank case plug and drain off the flushing oil, then replace plug and refill with fresh oil. (See Answer No. 3.)

**How often should Commutator be oiled?**

**Answer No. 103**

Keeping the commutator well oiled is a matter of far greater importance than many drivers believe, and is necessary in order to have a smooth operating engine.

Lubrication Chart. (Cut No. 16)

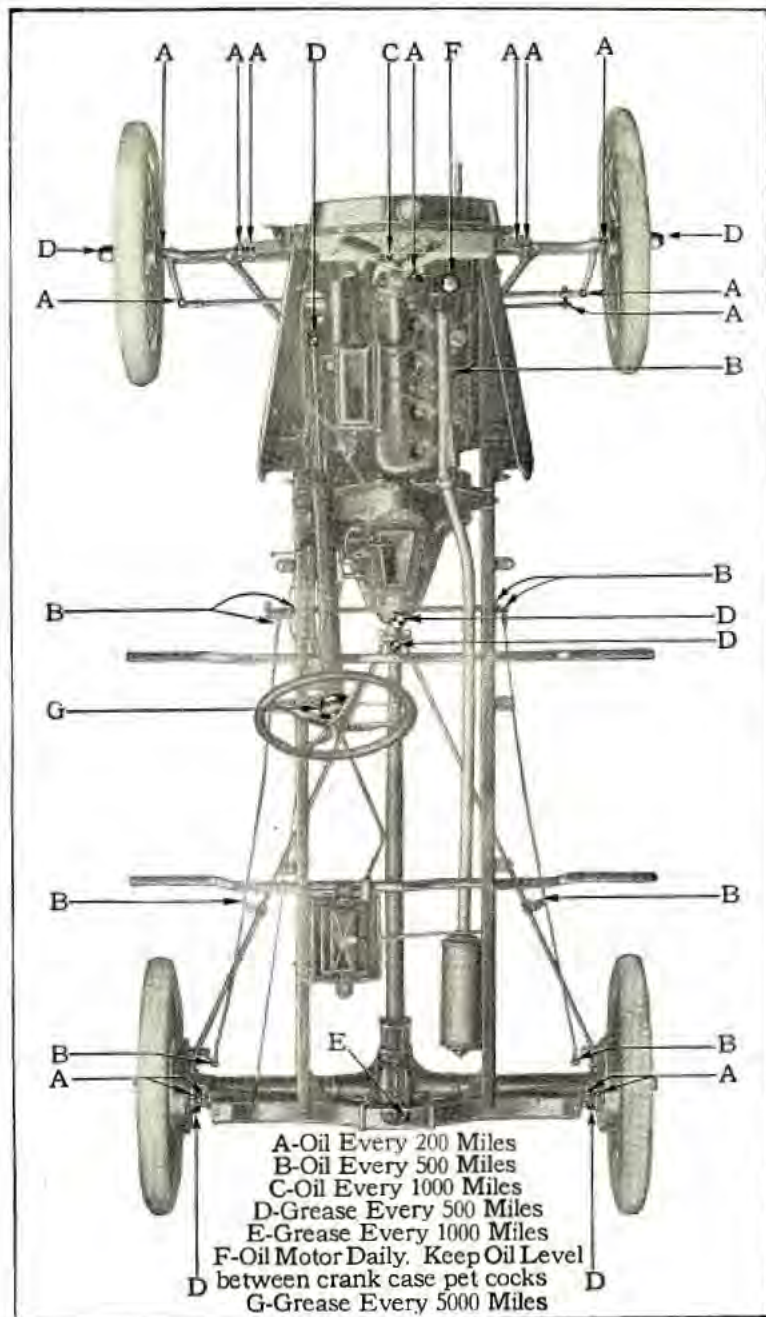



Don't be afraid to put a little oil into the commutator every other day—at least every 200 miles. Remember that the commutator roller revolves very rapidly, and without sufficient lubrication the parts soon become badly worn. When in this condition perfect contact between the roller and the four contact points is impossible; as a result the engine is apt to misfire when running at a good rate of speed.

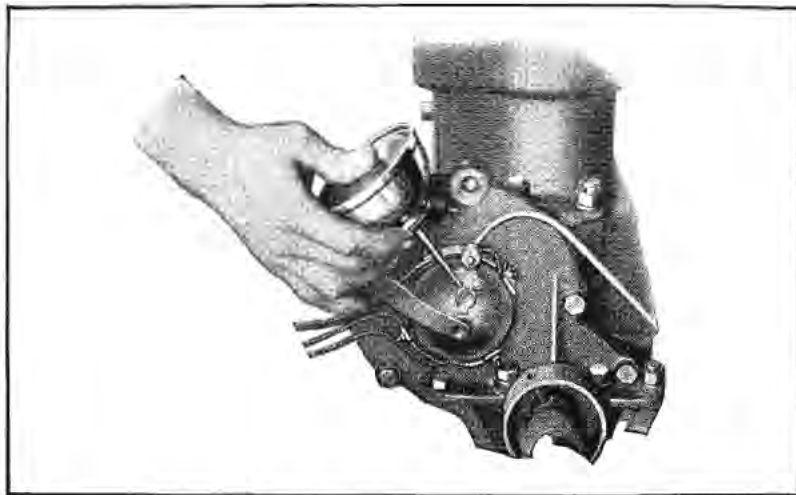

Oiling the Ford Commutator. (Cut No. 17)

#### What about Lubricating the Differential?

Do not make the mistake of putting too much grease in the differential housing. The housing should not be more than one-third full. The differential is supplied with the required amount of lubrication when the car leaves the factory. The oil plug should be removed about every 1000 miles and more grease added if necessary. If a fluid grease is used the level should be approximately one and one-half inches below the oil hole.

#### Answer No. 104

## Care of the Tires

#### How are Ford Tires removed?

#### Answer No. 105

First, jack up the wheel clear of the road. The valve cap should be unscrewed, the lock nut removed and the valve stem pushed into the tire until its bead is flush with the rim. This done, loosen up the bead of the casing in the clinch of the rim by working and pushing with the hands, then insert one of the tire irons or levers under the beads. The tire iron should be pushed in just enough to get a good hold on the under side of the bead, but not so far as to "pinch" the inner tube between the rim and the tool. A second iron should be inserted in the same fashion some seven or eight inches from the first, and the third tool the same distance from the second. As a clincher tire must be pried over the clinch, three levers will come in handy in a case of a "one-man job," and the knee of the driver can be used to good advantage to hold down one lever while the other two are being manipulated in working the casing clear of the rim. After freeing a length of the bead from the clinch, the entire outer edge of the casing may be readily detached with the hands, and the damaged inner tube removed and "patched" or a spare tube inserted. Always use plenty of soapstone in replacing an inner tube.

#### How are Casings repaired?

#### Answer No. 106

Should the casing be cut so there is danger of the inner tube being blown through it, a temporary repair can be made by cementing a patch, such as sold by Ford Dealers, on the inside of the casing. Before applying the patch, the part of the casing affected should be cleaned with gasoline and when dry, rubber cement applied to the casing only. Cut the required size patch and as soon as the cement on the casing is dry remove the white surface from the patch and apply it to the cut, smoothing it down carefully with the fingers so as to insure perfect contact. It is sometimes advisable to apply a patch to the outside of the casing also to keep out sand and water.

#### How may Tire Expense be reduced?

#### Answer No. 107

Tire cost constitutes one of the most important items in the running expenses of an automobile. To get the most service at the least expense, the tires should be inspected frequently and all small cuts or holes properly sealed or repaired—thus preventing dirt and water working in between the rubber tread and the fabric, causing blisters or sand boils.

Tires should never be run partially deflated, as the side walls are unduly bent and the fabric is subject to stresses which cause what is known as rim cutting. The chances of getting a puncture will be greatly reduced by keeping your tires properly inflated, as a hard tire exposes much less surface to the road than a soft tire, and also deflects sharp objects that would penetrate a soft tire.

Following is a table showing correct tire pressure for tires on Ford cars and trucks:

#### HIGH PRESSURE TIRES

Cars.....	Front, 55 lbs.	Rear, 55 lbs.
Trucks.....	Front, 55 lbs.	Rear, 80 lbs.

#### BALLOON TIRES

Roadster.....	Front, 27 lbs.	Rear, 27 lbs.
Touring Car.....	Front, 27 lbs.	Rear, 27 lbs.
Coupe.....	Front, 27 lbs.	Rear, 27 lbs.
Tudor Sedan.....	Front, 27 lbs.	Rear, 30 lbs.
Fordor Sedan.....	Front, 27 lbs.	Rear, 30 lbs.
Roadster—with Pick-up Body.....	Front, 27 lbs.	Rear, 30 lbs.

Running a tire flat, even for a short distance, is sure to be costly. Better run on the rim, very slowly and carefully, rather than on a flat tire.

Remember that fast driving and skidding shorten the life of the tires. Avoid locking the wheels with the brakes—no tire will stand the strain of being dragged over the pavement in this fashion.

Avoid running in street car tracks, in ruts, or bumping the sides of the tire against the curbing.

The wheel rims should be painted each season and kept free from rust.

When a car is idle for any appreciable length of time, it should be jacked up to take the load off the tires. If the car is laid up for many months it is best to remove the tires, and wrap up the outer casings and inner tubes separately, and store them in a dark room not exposed to extreme temperatures. Remove oil or grease from the tires with gasoline. Remember that heat, light and oil are three natural enemies of rubber.

*How is a puncture in the Inner Tube repaired?*

*Answer No. 108*

After locating the puncture, carefully clean the rubber around the leak with benzine or gasoline, then roughen the surface to give a hold for the cement. Apply one coat of cement to the tube allowing it to dry thoroughly. Cut a piece of patching material to the required size, and when the cement is dry remove the white surface from the face of the patch and apply it to the tube, pressing it down firmly and smoothly. Examine the casing carefully to make sure there are no cuts which will cause a further puncture. If any are found, repair according to instructions in Answer No. 106. Before the tube is put back into the casing plenty of talc powder should be sprinkled into the latter. In replacing the tire on the rim be very careful not to pinch the tube.

## Points on Maintenance

*What is the proper way to wash the Car?*

*Answer No. 109*

Always use cold or lukewarm water—never hot water. If a hose is used, don't turn on the water at full force, as this drives the dirt into the varnish and injures the finish. After the surplus mud and grime have been washed off take a sponge and clean the body and running gear with a tepid solution of water and Ivory or linseed oil soap. Rinse off with cold water; then rub and polish the body with a chamois skin. A body polish of good quality may be used to add lustre to the car. Grease on the running gear may be removed with a gasoline-soaked sponge or rag. The nicked parts may be polished with a good nickel polish. An excellent body polish and nickel polish may be purchased from the Ford dealer.

*What care does Top need?*

*Answer No. 110*

When putting the top down be careful in folding to see that the fabric is not pinched between the bow spacers, as they will chafe a hole through the top very quickly. Applying Ford top dressing will greatly improve the appearance of an old top.

*What should be done when the Car is stored?*

*Answer No. 111*

Drain the water from the radiator, and then put in about a quart of denatured alcohol to prevent freezing of any water that may possibly remain. Remove cylinder head and clean out any carbon deposits in combustion chamber. Draw off all the gasoline. Drain the dirty oil from the crank case and flush the crank case as directed in Answer No. 102. Refill the crank case with fresh oil and run the engine enough to cover the different parts with oil. Remove the tires and store them away. Wash the car, and if possible cover the body with a sheet of muslin to protect the finish.



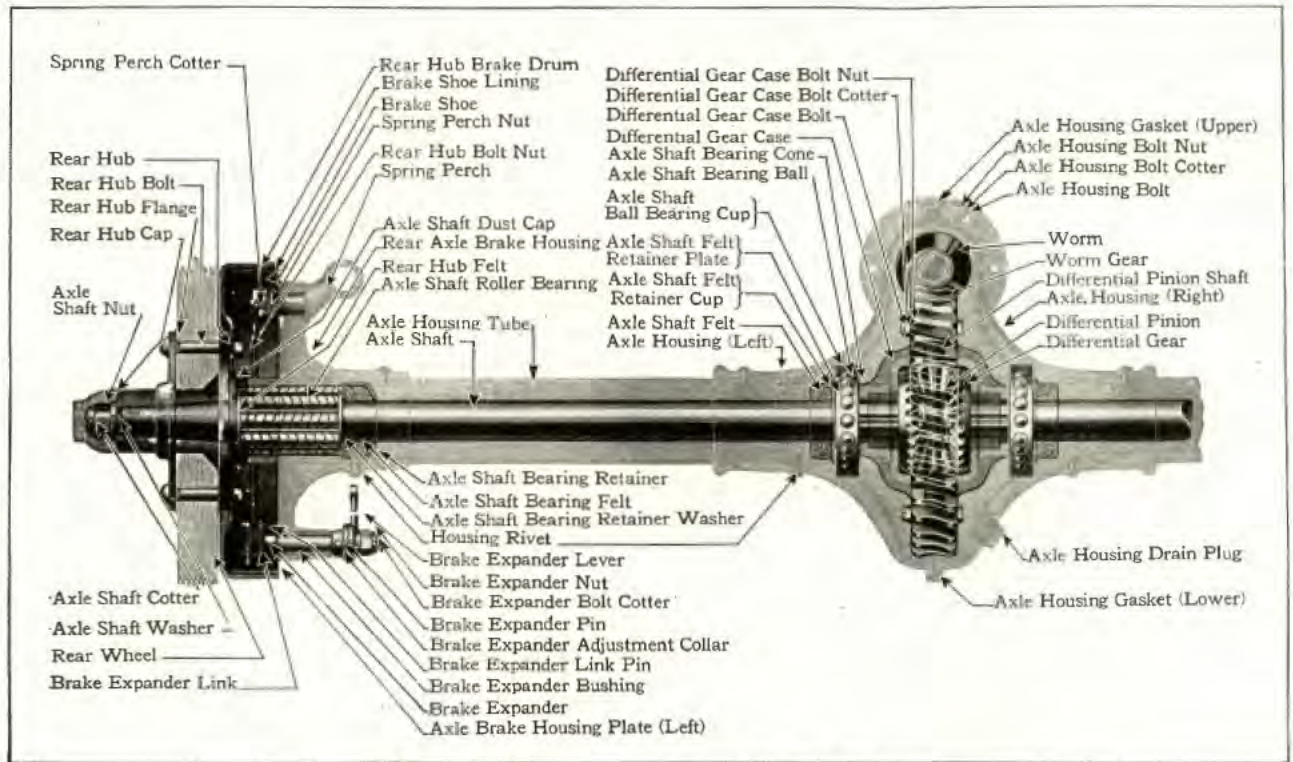

Truck Rear Axle—Longitudinal View. (Cut No. 18)

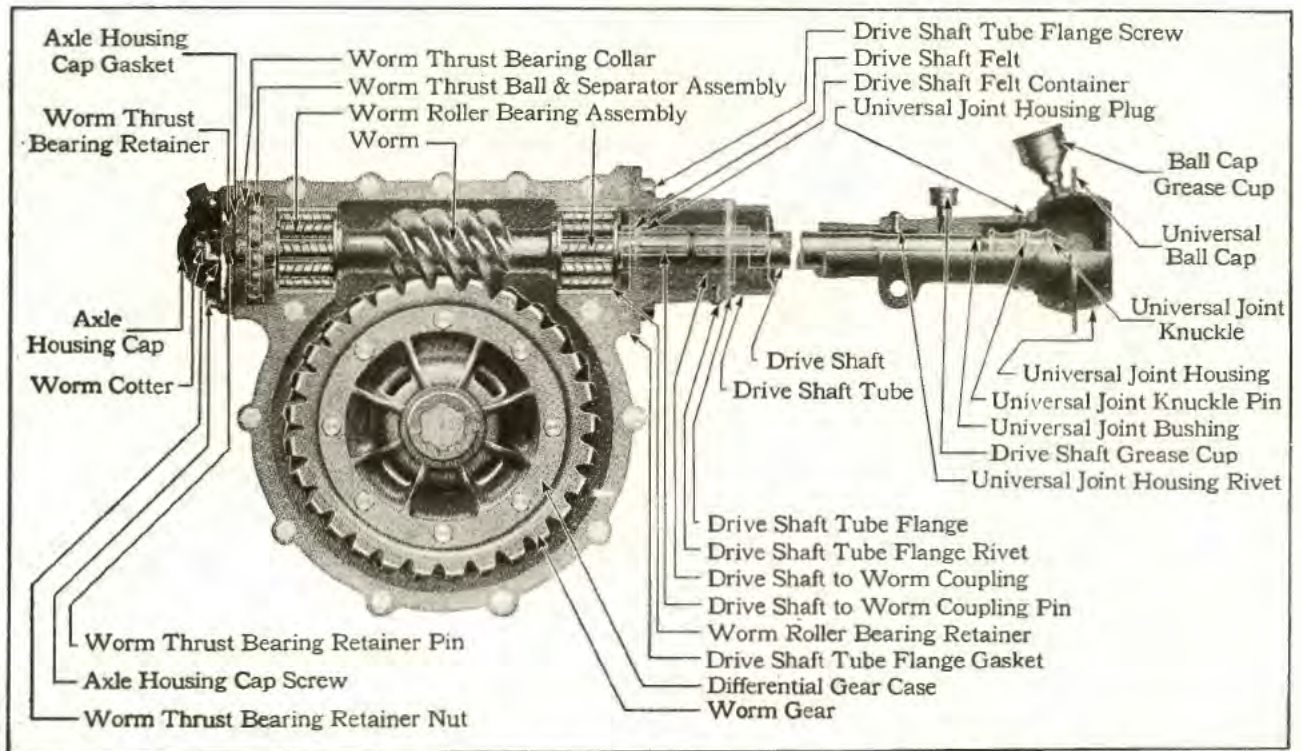

Truck Rear Axle—Cross Section showing Worm and Worm Gear. (Cut No. 19)



## The Ford Model T One Ton Truck

*Do the Instructions relative to the Car apply to the Truck?*

*Answer No. 112*

The answers pertaining to the car are applicable to the truck, with the exception of Nos. 79, 80 and 82.

*How are the Rear Axle and Differential disassembled?*

*Answer No. 113*

With the universal joint disconnected, remove the bolt in front end of radius rods and the cap screws which hold the drive shaft tube to the rear axle housing. Then remove the rear axle housing cap; also the bolts which hold the two halves of the differential housing together. With the differential exposed to view, the manner of disassembling it will be apparent. Care must be exercised to get every part back in its correct position when reassembling, being sure to use new paper liners.

*How is the Worm removed?*

*Answer No. 114*

To remove the worm, drive out the pins which hold the coupling to the worm and drive shaft. Then remove the felt washer, roller bearing sleeve, and roller bearing by slipping them over the coupling. Drive the coupling off from the drive shaft and then force the worm from the coupling. Removing the worm nut will permit the removal of the retaining washer, thrust bearing and rear worm roller bearing. In reassembling be sure that the pin which holds the retaining washer stationary is in place.

*How is the Differential Gear removed from the Shaft?*

*Answer No. 115*

The differential gear is fastened to the inner end of the rear axle shaft by means of splines, and is held in position by a ring which is in two halves and fits in a groove in the rear axle shaft. To remove the gear, force it down on the shaft, that is, away from the end to which it is fastened, drive out the two halves of the ring in groove in shaft with screw-driver or chisel, and force the gear off the end of the shaft.

*What about Lubricating the Rear Axle?*

*Answer No. 116*

Extreme care must be used in lubricating the differential. An A-1 heavy fluid or semi-fluid oil, should be used and carried at a level with the upper oil plug. The differential is supplied with the required amount of lubricant when the truck leaves the factory and the supply should be maintained by replenishments as required. After running the truck about 500 miles, the oil should be drained off by removing the lower oil plug, and the differential filled with fresh lubricant. This operation should be repeated at approximately 1000 miles, and after that whenever necessary. The rear axle outer roller bearings are lubricated by means of dope cups. These cups should be kept filled with a good grade of grease and given a full turn every 100 miles. Before putting the truck back in service after the rear axle has been taken down, fill the differential with oil, jack up the axle and run it for five or ten minutes to insure proper lubrication of all bearings.

## The Ford Starting and Lighting System

*Of what does the Starting and Lighting System consist?*

*Answer No. 117*

The starting and lighting system is of the two unit type and consists of the starting motor, generator, storage battery, ammeter, and lights, together with the necessary wiring and connections.

*Where is the Starter located?*

*Answer No. 118*

The starting motor is mounted on the left-hand side of the engine and bolted to the transmission cover. When in operation the pinion on the starter drive shaft engages with the teeth on the flywheel.

*What if the Engine fails to start?*

*Answer No. 119*

If the starting motor is turning the crank shaft over and the engine fails to start, the trouble is not in the starting system. In this event take your foot off the starter switch at once so as not to unnecessarily discharge the battery, and inspect the carburetor and ignition system to determine the trouble.

*What if the Starting Motor fails to act?*

*Answer No. 120*

If the starting motor fails to act, after depressing the starter switch, first inspect the terminal on the starting motor, the two terminals on the battery and the two terminals on starting switch, making sure all of the connections are tight; then examine the wiring for a break in the insulation that would cause a short circuit. If the wiring and connections are O. K. and the starting motor fails to act, test the battery with a hydrometer. If the hydrometer reading is less than 1.225 the trouble is no doubt due to a weak or discharged battery.

*What if the driver steps on Starting Button when engine is running?*

*Answer No. 121*

Should the driver accidentally step on the starting switch while the engine is running, no harm will result. The pinion merely touches the revolving flywheel gear once and immediately rotates with the threaded shaft out of contact with the flywheel, in the same manner as when it has been disengaged by the engine's starting.

*How is the Generator operated?*

*Answer No. 122*

The generator is mounted on the right-hand side of the engine and bolted to the cylinder front end cover. It is operated by the pinion on the armature shaft engaging with the large time gear. The charging rate of generator is set so as to cut in at engine speeds corresponding to 10 miles per hour in high speed and reaches a maximum charging rate at 20 miles per hour. At higher speeds the charge will taper off, which is a settled characteristic of a generator. This operation of cutting in and cutting out at suitable speeds is accomplished by the cut-out, which is mounted on the generator. This cut-out is set properly at the factory and should not under any circumstances be tampered with.



**What about Oiling?**

**Answer No. 123**

The starting motor is lubricated by the Ford splash system, the same as the engine and transmission. The generator is lubricated by a splash of oil from the time gears. In addition an oil cup is located at the end of the generator housing and a few drops of oil should be applied occasionally.

**What should be done when repairing the Ignition?**

**Answer No. 124**

The introduction of a battery current into the magneto will discharge the magnets and whenever working on the ignition system or wiring do not fail to disconnect the positive wire from the battery. The end of this wire should be wound with tape to prevent its coming in contact with the terminal again.

**How does the Ammeter operate?**

**Answer No. 125**

The ammeter is located on the instrument board. This indicator registers "charge" when the generator is charging the battery and "discharge" when the lights are burning and the engine not running above 10 miles per hour. At an engine speed of 15 miles per hour or more the ammeter should show a reading of from 8 to 10 with lights turned off. If the engine is running above 15 miles per hour and the ammeter does not show a proper reading, first inspect the terminal posts on the ammeter, making sure that the connections are tight, then remove cut-out, and with the engine running at a moderate speed, take a pair of pliers or a screw-driver and short-circuit the terminal stud on the generator to the generator housing. If the generator is O. K., a good live spark will be noted. (DO NOT RUN THE ENGINE ANY LONGER THAN IS NECESSARY WITH THE CUT-OUT REMOVED.) Next inspect the wiring from the generator through the ammeter, to the battery for a break in the insulation that would result in a short-circuit. If the trouble is not located, then remove the dust cap from the end of generator and thoroughly clean the generator commutator, using for this work a fine grade of sandpaper which has been slightly oiled. With the motor running, hold the sandpaper against the commutator with the fingers, until all dirt has been removed and a bright surface attained.

**How are the Lights operated?**

**Answer No. 126**

The lighting system consists of two headlights and a tail light operated by a combination lighting and ignition switch located on the instrument board. The headlamp bulbs are of 6-8 volt, double filament gas filled type. The major filament is 21 candle-power, and the minor filament is 2 candle-power. The small bulb used in the tail light is of 6-8 volt, single contact, two candle-power type. All of the lamps are connected in parallel so that the burning out or removal of any one of them will not affect the other. Current for the lamps is supplied by the battery. Do not connect the lights to the magneto as it will result in burning out the bulbs and might discharge the magnets. Cut No. 21 shows the different circuits and the course of the current.

**What Attention do the Electric Headlights require?**

**Answer No. 127**

When the car is delivered to the owner, the headlamps are properly focused and aligned, and they should require no attention other than replacement of burned out bulbs or broken lenses, and re-focusing or re-aligning should they get out of focus or alignment. Headlights equipped with the Ford refracting lens

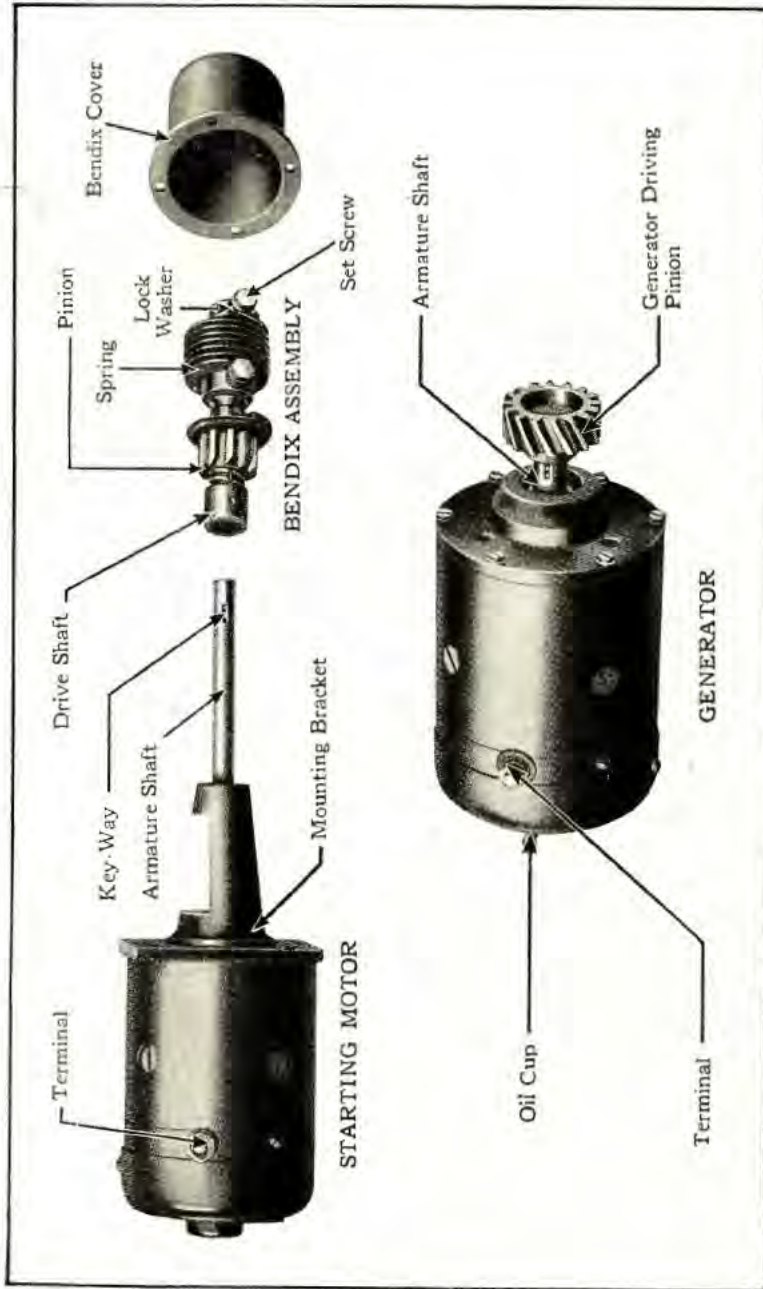

Starter and Generator Units. (Cut No. 20)



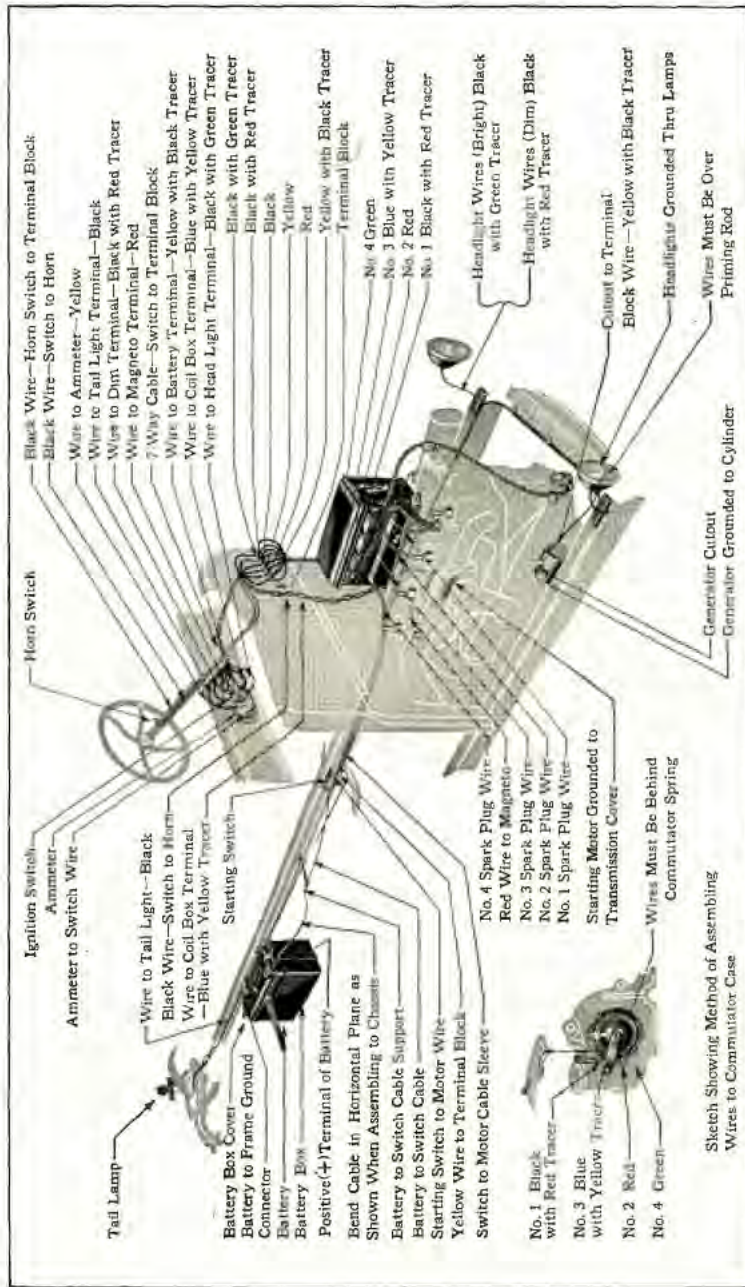

Wiring Diagram. Cars Equipped with Starter. (Cut No. 21)

and Ford 21 candle-power gas filled bulbs, when properly focused and aligned, pass the lighting requirements of all states, and should they get out of focus or alignment they should immediately be re-focused and re-aligned.

**How is the Headlight Lens installed?**

**Answer No. 128**

Remove the door by pressing in and turning to the left until the pins in the door rim disengage from the notches in the lamp case. You can then readily see how the lens fits into the door rim.

**What about Bulb replacement?**

**Answer No. 129**

When replacing burned out bulbs purchase genuine Ford bulbs (marked with the name FORD on the base), as satisfactory results cannot be obtained with the many inferior bulbs now on the market. It is absolutely essential that the Ford 21 candle-power gas filled bulbs be used in the lamps equipped with the Ford Refracting Lens as the use of any other than genuine Ford bulbs may result in the lights failing to meet the lighting requirements of the various states. Care should be exercised not to touch the reflector except with a soft clean cloth.

**How are the Headlights focused?**

**Answer No. 130**

Place the empty car on a level surface facing a white wall or screen 25 feet in front of the headlights. This wall must be shielded from direct light sufficiently so that the light spots from the headlights can be clearly seen and should be marked off with black lines as follows: One horizontal line 28 inches above the surface on which the car is standing, and three vertical lines 14 inches apart. The center line of the car should be directly in front of the center vertical line. Turn on the bright lights, then focus by means of the screw on the back of the lamp, adjusting to obtain an elongated elliptical spot of light on the wall with its long axis horizontal. (See plate No. 22.) Adjust the bulb to obtain as good contrast and as well defined cut-off across the top of the spot of light as possible. With the lights thus focused for the "bright" filament, the "dim" will be satisfactory.

**How are Headlights aligned?**

**Answer No. 131**

Headlamps may be aligned by bending the headlamp brackets so that the tops of the bright spot on the wall or screen 25 feet in front of the car are at a line 28 inches above the level surface on which the car stands and so that the beam of light from each headlamp extends straight forward; that is, with the centers of the elliptical spots of light 28 inches apart. (See plate No. 23.) Owners may prefer to have their lamps focused and aligned by an authorized Ford dealer as all Ford dealers are specially equipped to do this work

**What about repairing Starter and Generator?**

**Answer No. 132**

If either the starter or generator fails to give proper service, the owner should at once consult an authorized Ford dealer. Owners should not attempt to repair or adjust the mechanism of the starter and generator.

Sketch Showing Method of Assembling Wires to Commutator Case





(Cut No. 22)

Left Headlamp Properly Focused and Aligned.



(Cut No. 23)

Both Headlamps Properly Focused and Aligned.

*How is the Starter removed?*

*Answer No. 133*

When removing the starter first remove the engine pan on the left-hand side of the engine and with a screwdriver remove the four small screws holding the starter drive cover to the transmission cover. Upon removing cover and gasket, turn the starter drive shaft around so that the set screw on the end of the shaft is at the top. Immediately under the set screw is placed a lock washer, designed with lips or extensions opposite each other. One of these is turned against the spring and the other is turned up against the side of the screw head. Bend back the lip which has been forced against the screw and remove the set-screw. As the lock washer will no doubt be broken or weakened in removing the starter, a new one must be used when replacing it. Next, remove head and key and pull the starter drive assembly out of the housing, being careful that the small key is not misplaced nor lost. Remove the four screws which hold the starter housing to the transmission cover, and pull out the starter, taking same down through the chassis—this is why it was necessary to remove the engine pan. Extreme care should be used in removing the starter drive and other parts that none are misplaced nor lost and that they are replaced in their former position. In replacing the starter, be sure that the terminal connection is placed at the top. If the car is to be operated with the starter removed, be sure to put the transmission cover plates in position. These plates may be obtained from the nearest dealer.

*How is the Starter Drive assembled to the Starting Motor?*

*Answer No. 134*

When assembling the starter drive to the starting motor shaft, care must be used to see that the stop nut or bearing which enters the mounting bracket on the starting motor is not too tight; also that the bearing is in proper alignment with the bracket. The bearing should be oiled and then fitted so that it can be turned readily with the fingers. If the bearing is too tight, it should be dressed down with an oil stone. Too tight a fit will cause the bearing to freeze to the bracket, resulting in serious damage to the starter.

*How is the Generator removed?*

*Answer No. 135*

If it is found necessary to remove the generator, first take out the three cap screws holding it to the front end cover and by placing the point of a screw-driver between the generator and front end cover, the generator may be forced off the engine assembly. Always start at the top of the generator and force it backward and downward at the same time. A plate may be obtained from the nearest dealer to place over the opening in the time gear cover if the car is to be operated with the generator removed.

*What should be done when replacing the Generator?*

*Answer No. 136*

When installing the generator, the drive pinion must be properly meshed with the large time gear. The generator bracket, that is, the section to which the generator is bolted is separate from the cylinder block and the meshing of the generator driving pinion with the large time gear can be regulated by the use of one or more paper gaskets between the bracket and the cylinder block. The bracket should rest tightly on the crankcase gasket and line up with the face of the time gear case. If these gears are meshed too tightly, a humming noise will result, also the generator shaft will be thrown out of alignment.



*Can the Engine be run with the Generator disconnected from the battery?*

*Answer No. 137*

If for any reason the engine is run with the generator disconnected from the battery, as on a block test, or when battery has been removed for repair or recharging, be sure that the generator is grounded by running a wire from the terminal on generator to one of the dust cover screws in the yoke. Two strands of shipping tag wire may be used for this purpose. Be sure that the connections at both ends of the wire are tight. Failure to do this when running the engine with the generator disconnected from the battery will result in serious damage to the generator. **Never ground the generator through the cut-out.**

*What type of Battery is used?*

*Answer No. 138*

The Ford Starting System uses a six-volt, three-cell Ford battery.

*How are Hydrometer Readings taken?*

*Answer No. 139*

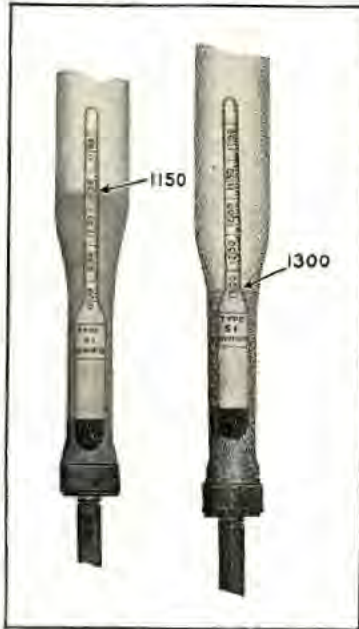

Hydrometer Readings. (Cut No. 24)

Hydrometer readings should be taken about every two weeks to make sure that the generator is keeping the battery charged. To take a hydrometer reading, remove the filling plugs (remove the plug from only one cell at a time). Next, insert the hydrometer syringe in the filler tube and draw up enough of the solution to float the glass bulb inside the instrument. The reading of the scale at the surface of the liquid (see Cut No. 26) gives the strength of the solution. Be sure to return the electrolyte to the cell from which it was taken. Following is a list of the readings with their indications. The readings in parentheses apply to batteries used in tropical climates where water never freezes. Readings of 1.275 (1.200) or more indicate a fully charged battery. Readings of less than 1.225 (1.130) but more than 1.150 (1.080) indicate complete discharge. Hydrometer tests taken immediately after filling with water and before it has become thoroughly mixed with the electrolyte will not show the true condition of the battery. If the hydrometer reading shows the battery less than one-half charged, it should be taken to the nearest authorized Ford Dealer for recharging. Continued operation in a less than half-charged condition is injurious to the battery somewhat as running

on a soft or deflated tire is injurious to the tire. Before replacing the battery, the cause of the discharged condition should be removed. It may be due to leaks or grounds in the car wiring or to the electric system having gotten out of adjustment so that the battery is not kept supplied with the proper amount of current from the generator. If the reading in one cell is more than 50 points

different from the others, it indicates that the cell is not in good order and the battery should be taken to an authorized Ford Dealer for attention.

*When should water be added to the Battery?*

*Answer No. 140*

Add nothing but pure water to the cells and do it often enough to keep the plates covered at all times. The solution (electrolyte) should be maintained at a level with the bottom of the filling tube. Distilled water, melted artificial (but not natural) ice and rain water, if obtained in the open country from a clean slate or shingle-covered roof, are generally satisfactory. All water for battery use should be kept in clean, covered vessels of glass, china, earthenware, rubber or lead. In cold weather add water only immediately before running the engine so that the charging will mix the water and electrolyte, and avoid freezing. If, for any reason, it is necessary to add acid, the battery should be taken to an authorized Ford Dealer.

*What care should be given the Filling Plugs and Connections?*

*Answer No. 141*

Keep the filling plugs and connections tight and the top of the battery clean. Wiping the battery with a rag moistened with ammonia will counteract the effect of any of the solution which may be on the outside of the battery. A coating of heavy oil or vaseline will protect the connectors from corrosion. It is of vital importance that the battery is firmly secured in its supporting brackets at all times. If clamps are loose, the battery will shift about in the compartment and result in loose connections, broken cells and other trouble. If repairs are necessary or if the car is to be laid up for the winter, take the battery to a skilled service man for proper attention and storage. Do not entrust the battery to inexperienced or unskilled hands.



## Summary of Engine Troubles and Their Causes

### ENGINE FAILS TO START

1. Gas mixture too lean.
2. Water in gasoline.
3. Vibrators adjusted too close.
4. Water or congealed oil in commutator.
5. Magneto contact point (in trans. cover) obstructed with foreign matter. (This would not apply when car is being started on battery.)
6. Gasoline supply shut off.
7. Carburetor frozen (in zero weather).
8. Water frozen in gasoline tank sediment bulb.
9. Ignition switch off.

### ENGINE LACKS POWER—RUNS IRREGULARLY

#### At Low Speeds.

1. Poor compression—account leaky valves.
2. Gas mixture too rich or too lean.
3. Spark plugs dirty.
4. Coil vibrator improperly adjusted
5. Air leak in intake manifold.
6. Weak exhaust valve spring.
7. Too great clearance between valve stem and push rod.
8. Too close gap between spark plug points.

#### At High Speeds.

1. Commutator contact imperfect.
2. Weak valve spring.
3. Too much gap in spark plug.
4. Imperfect gas mixture.
5. Vibrator points dirty or burned.

### ENGINE STOPS SUDDENLY

1. Gasoline tank empty.
2. Water in gasoline.
3. Flooded carburetor.
4. Dirt in carburetor or feed pipe.
5. Magneto wire loose at either terminal.
6. Magneto contact point obstructed.
7. Overheated—account lack of oil or water.
8. Gas mixture too lean.

### ENGINE OVERHEATS

1. Lack of water.
2. Lack of oil.
3. Fan belt torn, loose or slipping.
4. Carbon deposit in combustion chamber.
5. Spark retarded too far.
6. Gas mixture too rich.
7. Water circulation retarded by sediment in radiator.

### ENGINE KNOCKS

1. Carbon deposit on piston heads.
2. Loose connecting rod bearing.
3. Loose crank shaft bearing.
4. Spark advanced too far.
5. Engine overheated.

## Index

	Page		Page
<b>CARE OF TIRES</b>		<b>MAINTENANCE</b>	
Care of Inner Tubes.....	48	Care of Top.....	49
Casings—How Repaired.....	47	Storing Cars.....	49
How to Remove Tires.....	47	To Keep Car Clean.....	49
Repair Puncture.....	48		
<b>COOLING SYSTEM</b>		<b>MUFFLER</b>	
Causes of Overheating.....	17	What It Is For.....	38
Purpose.....	17	How to Disconnect.....	38
Radiator Care in Winter.....	18		
Repairing Radiator.....	18	<b>OPERATION</b>	
What to Do When Overheated.....	17	Adjustments—What to Do.....	7
<b>ENGINE</b>		Gasoline.....	3
Carbon—How Removed.....	13	Getting Ready to Start.....	3
Connecting Rod and Bearings.....	14	Hand Lever.....	6
Engine Fails to Start.....	62	Oiling.....	3
Engine Lacks Power—Runs Irregularly.....	62	Slow Speed, Brake and Reverse.....	6
Engine Stops Suddenly.....	62	Spark—How Controlled.....	7
Engine Overheats.....	62	Speed—How Controlled.....	7
Engine Knocks.....	62	Starting.....	5
Knocking—Causes.....	12	Starting in Cold Weather.....	6
Main Bearing—How Adjusted.....	14		
Piston.....	9	<b>REAR AXLE</b>	
Power Plant—How Removed.....	13	Differential Gear—How Removed.....	38
Valves.....	9	Rear Axle—How to Remove Parts.....	37
		Universal Joint—To Disconnect.....	37
<b>GASOLINE SYSTEM</b>		<b>RUNNING GEAR</b>	
Carburetor—How to Adjust.....	19	About Wheels.....	40
Carburetor—How Controlled.....	19	Care of Springs.....	42
Carburetor—Trouble.....	21	Its Care.....	39
Carburetor—How it Works.....	19	Lubricating the Bearings.....	42
<b>IGNITION SYSTEM</b>		Remove Front Axle.....	39
Coils.....	23	Roller Bearings—How Installed.....	41
Commutator—Its Purpose.....	25	Roller Bearing Cups—How Installed.....	41
Magneto.....	23	Steering Apparatus.....	42
Magneto Trouble.....	28	Wheels.....	40
Spark Plugs.....	25		
Where to Look for Trouble.....	26	<b>TRANSMISSION</b>	
<b>LUBRICATING SYSTEM</b>		Bands.....	31
How it Differs from Others.....	45	Clutch.....	29
Kind of Oil to Use.....	45	Planetary Transmission—What Is It.....	29
To Fill "Dope" Cups.....	45	Transmission—How Assembled.....	31

## Model T Truck

Lubricating the Differential.....	52
Worm, How Removed.....	52

## The Ford Starting and Lighting System

The Battery—Repairing and Recharging.....	60
Focusing and Aligning Headlights.....	57
The Generator—How Removed.....	59
Oiling the Starter and Generator.....	55
Starter—How Removed.....	59
Starter Drive—How Assembled to Starting Motor.....	59
Starting Motor—What if it Fails to Act.....	53
Type of System.....	53

*Ford*  
MANUAL

*Ford Motor Company*  
DETROIT, MICH.